

Anschlußbeispiele ISYGLT - BUS - Module

Stand : Juli 2005

L-St. (230V/50Hz)

N-St.

+24V

0V=

BUS-A

BUS-B

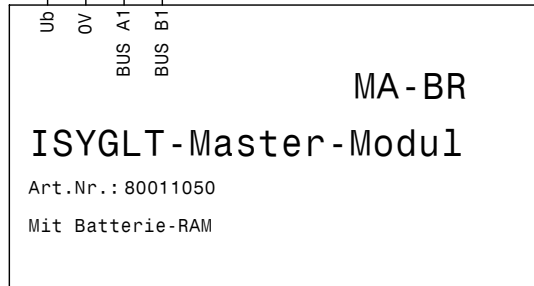
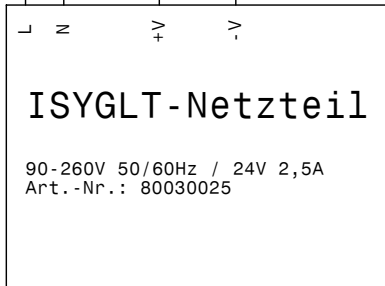

L-St. (230V/50Hz)

N-St.

+24V

0V=

BUS-A

BUS-B

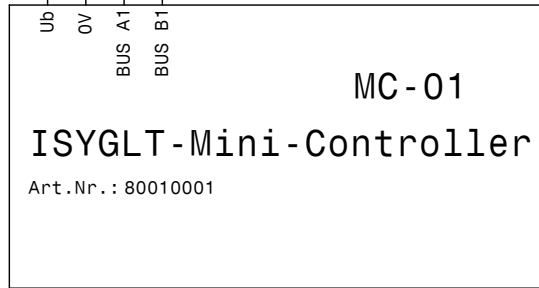
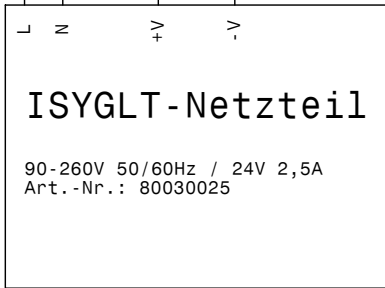

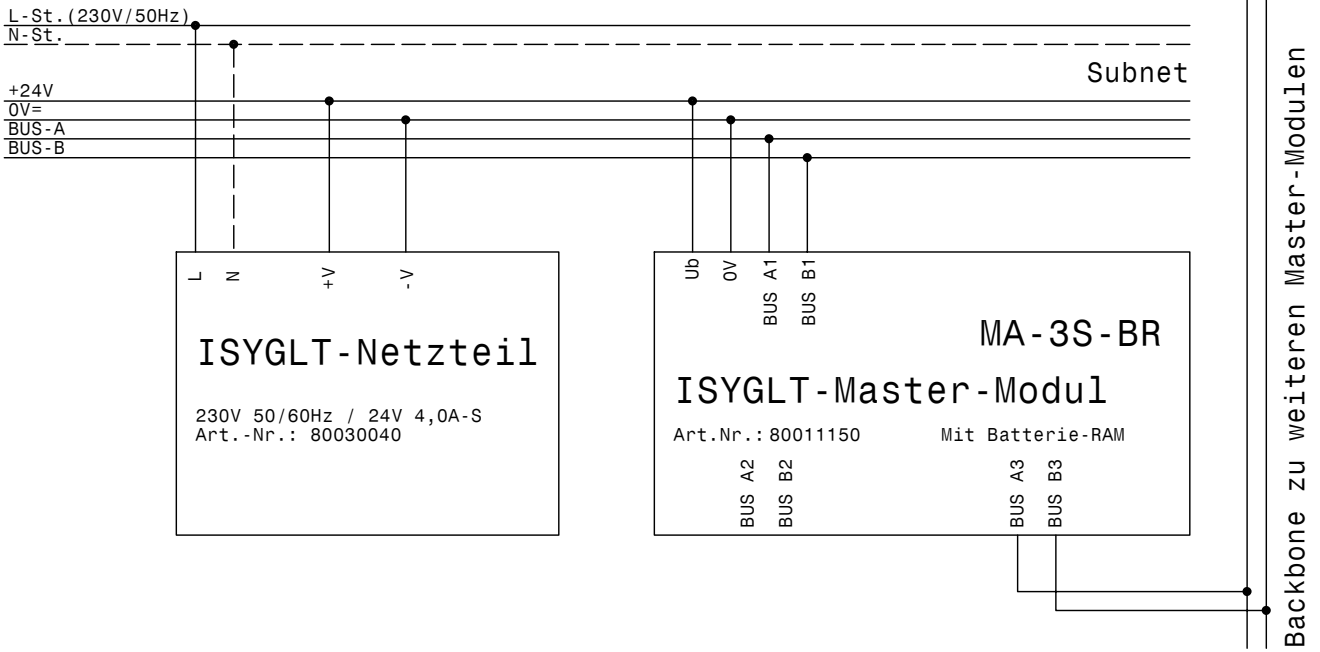
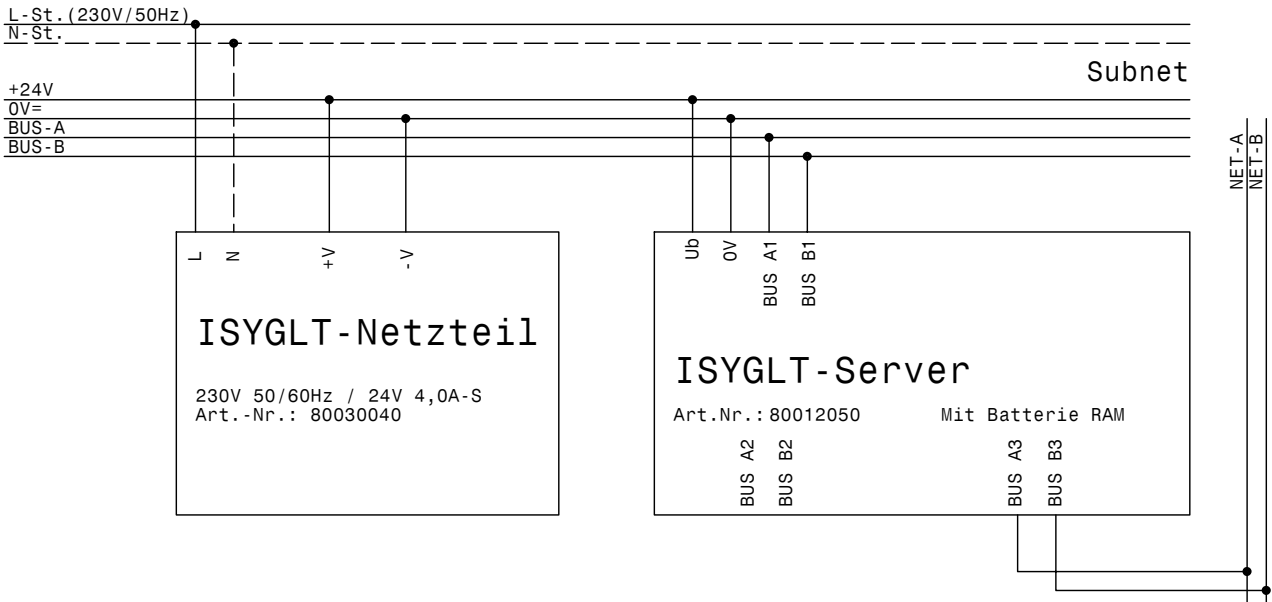

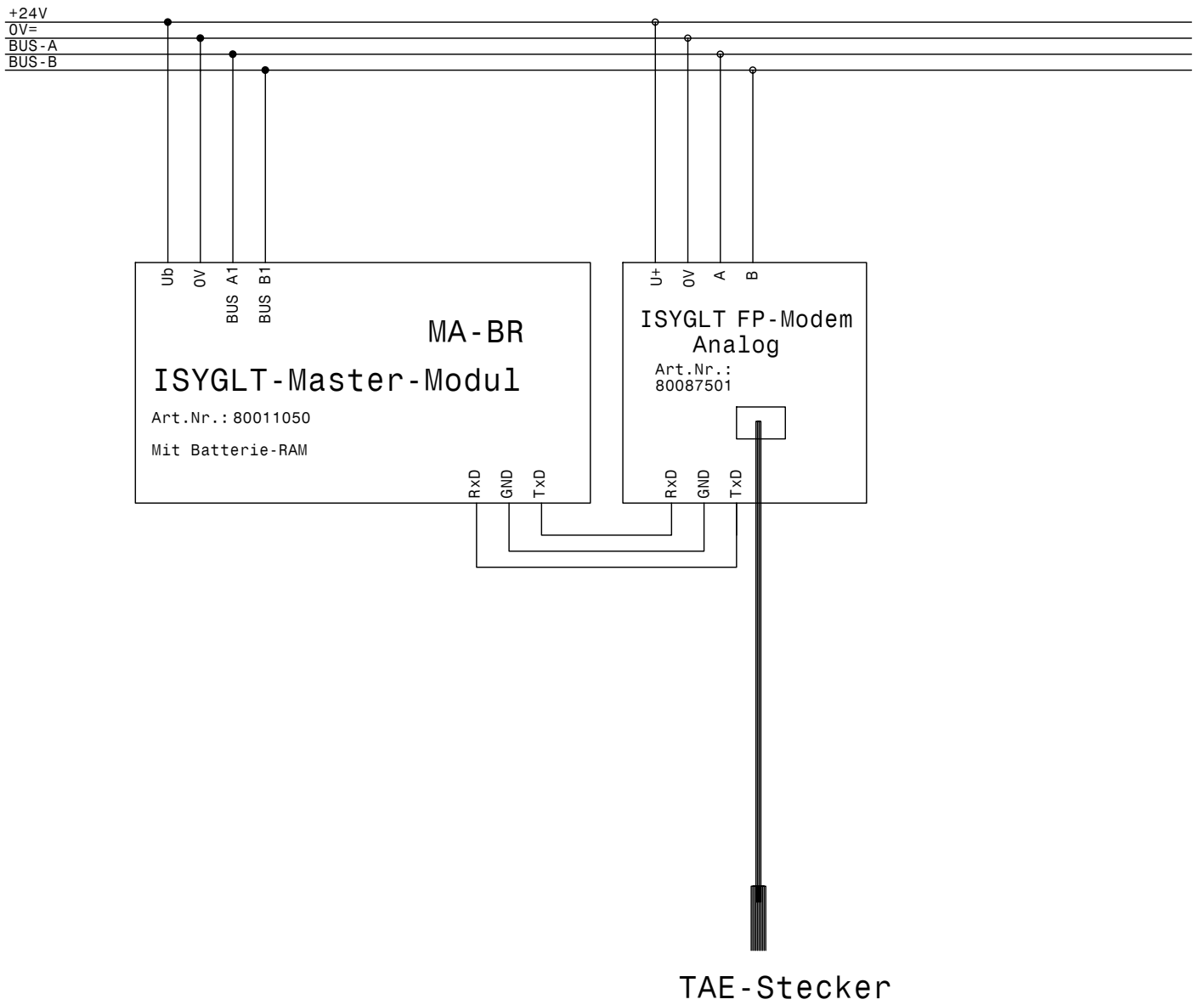

Temperaturfühler

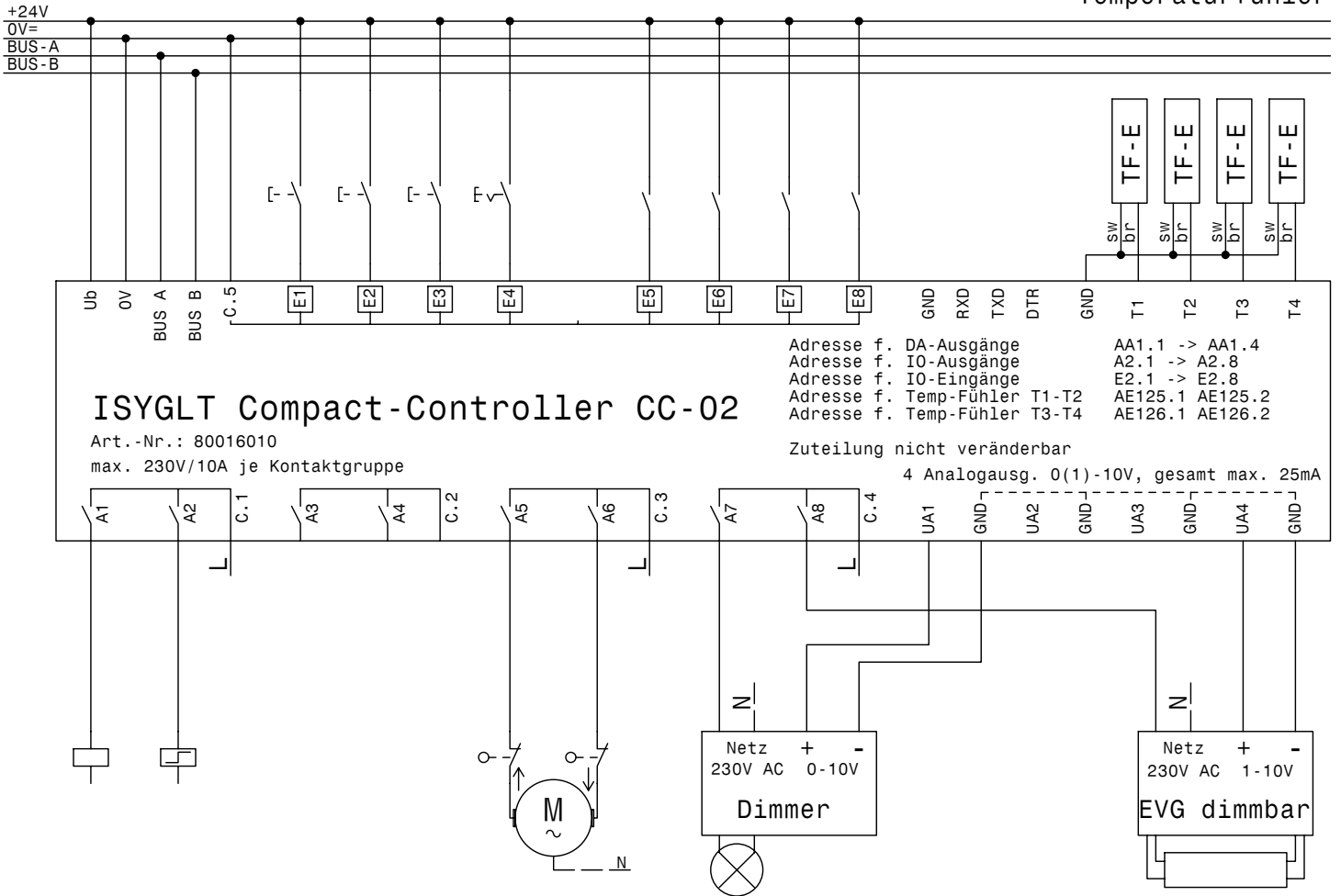

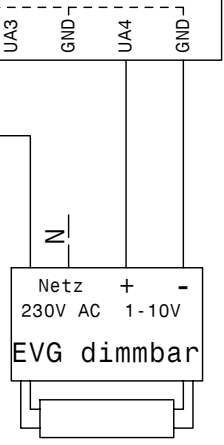
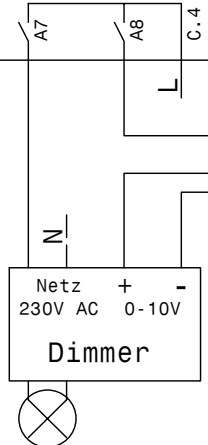
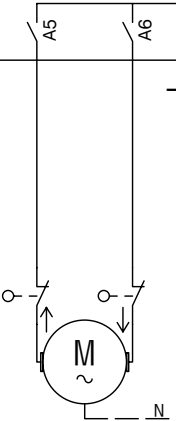
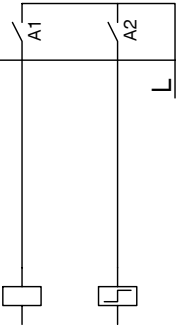
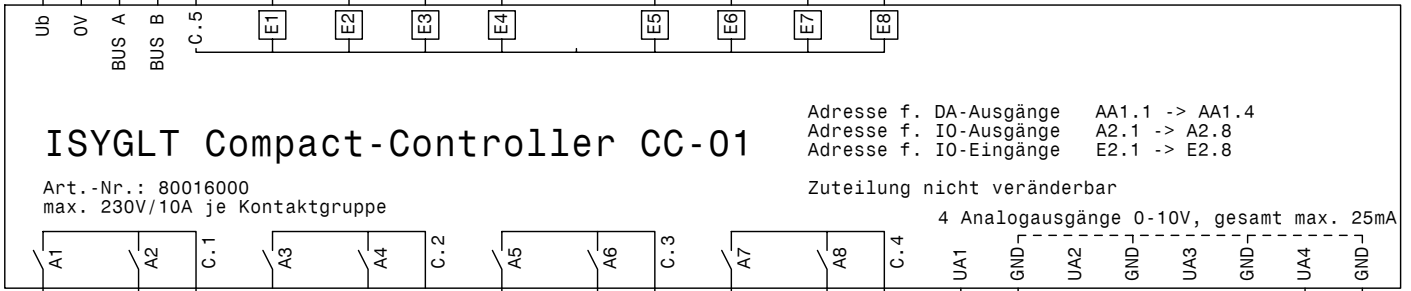

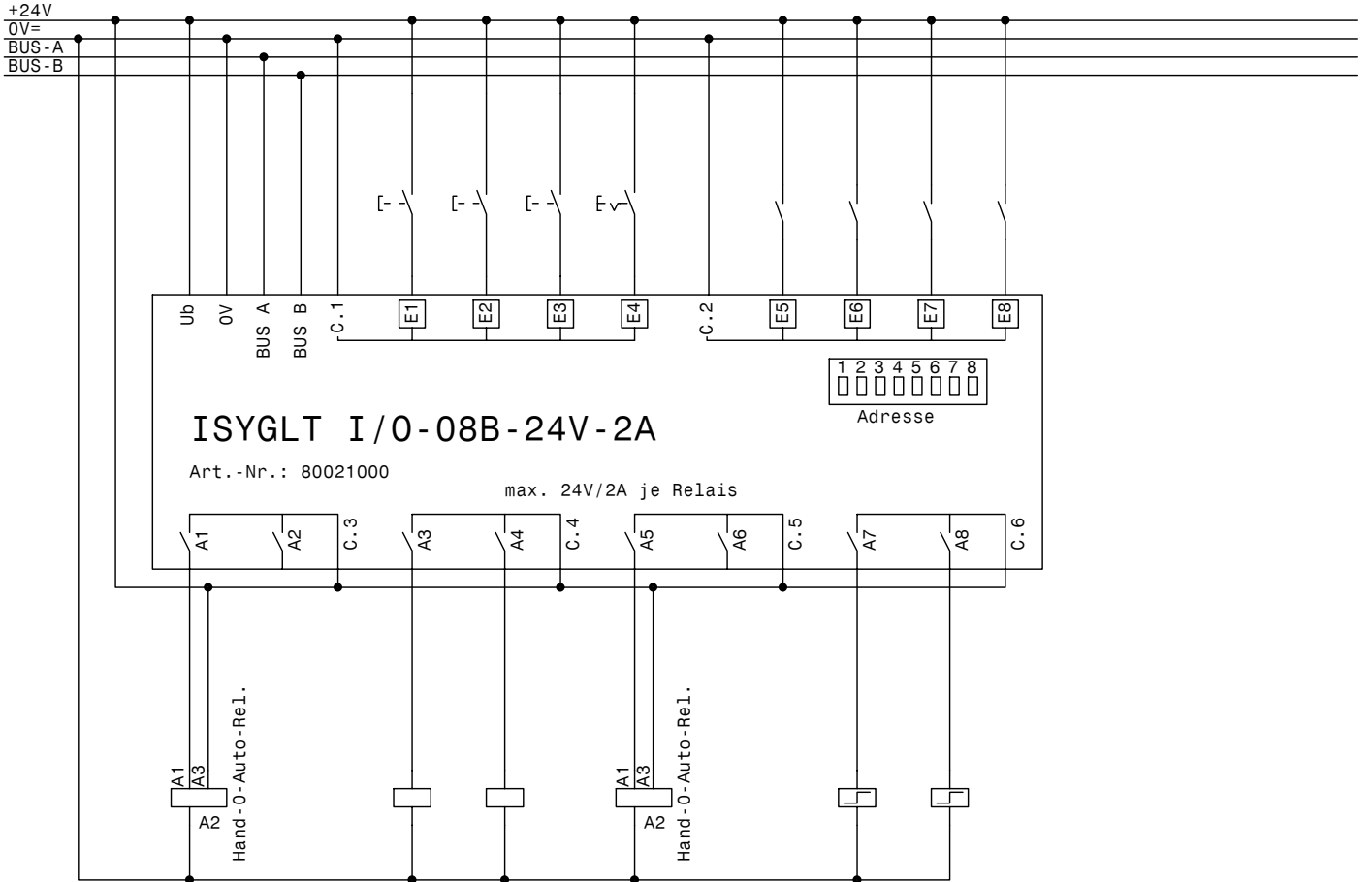

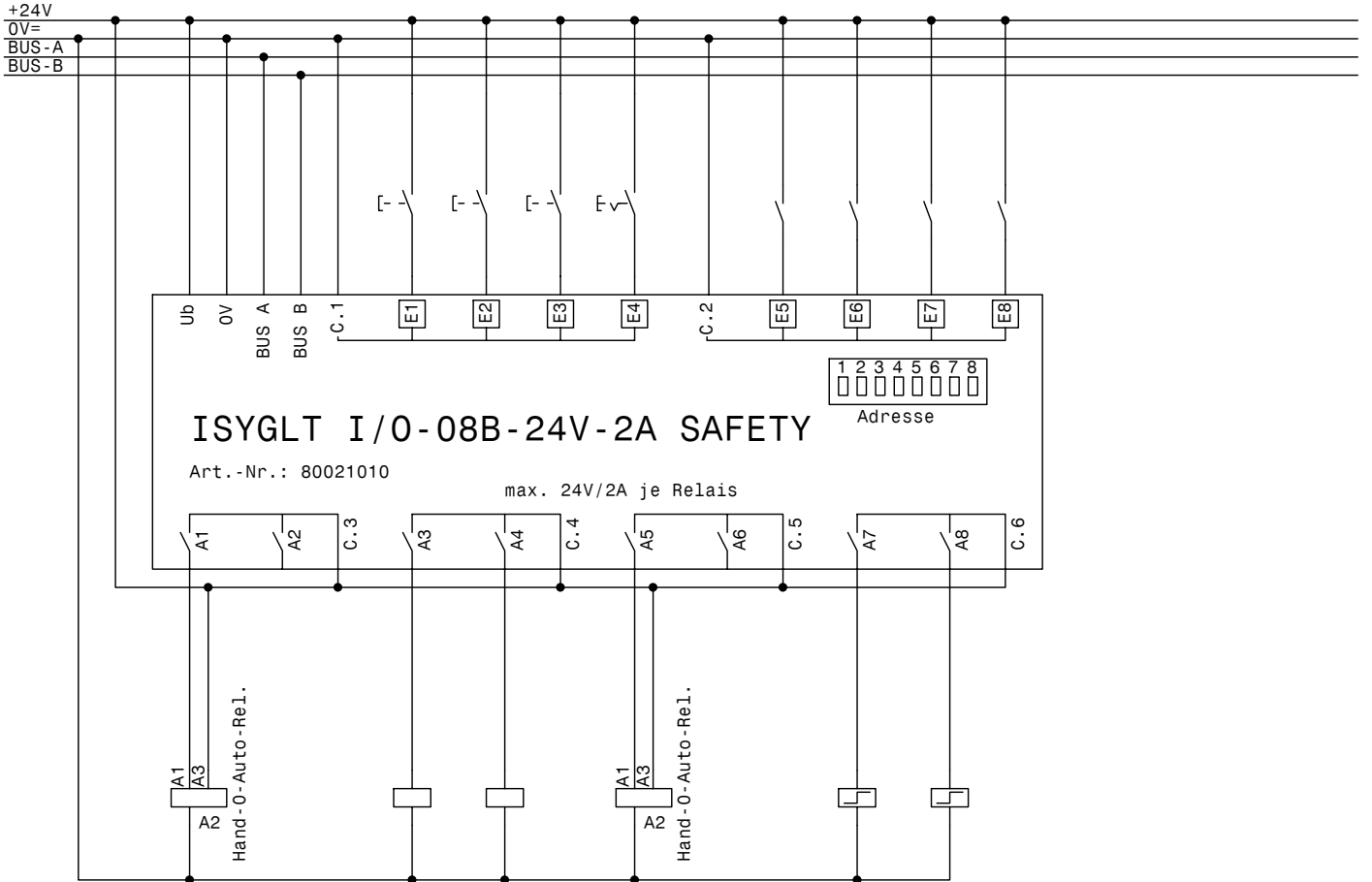

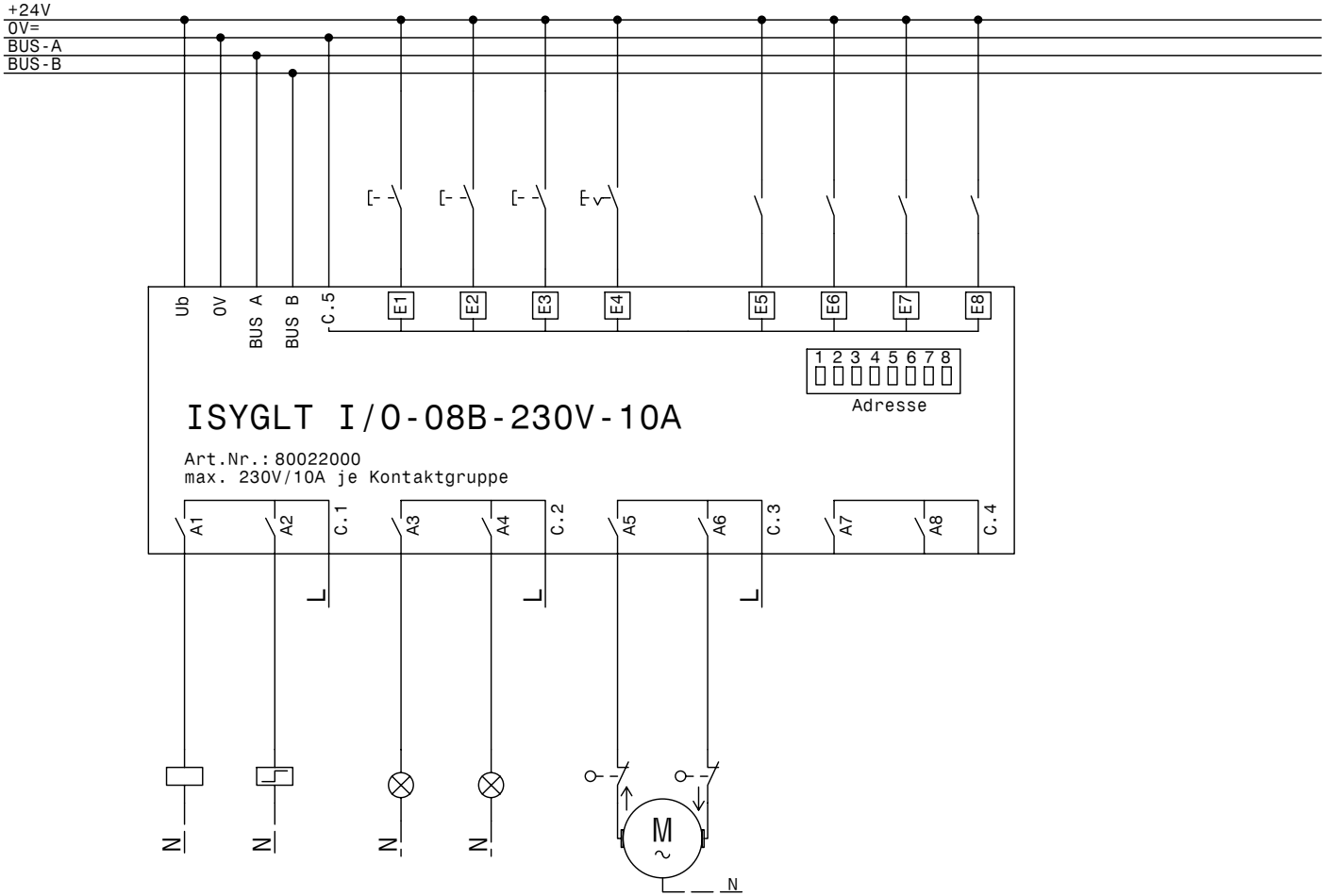

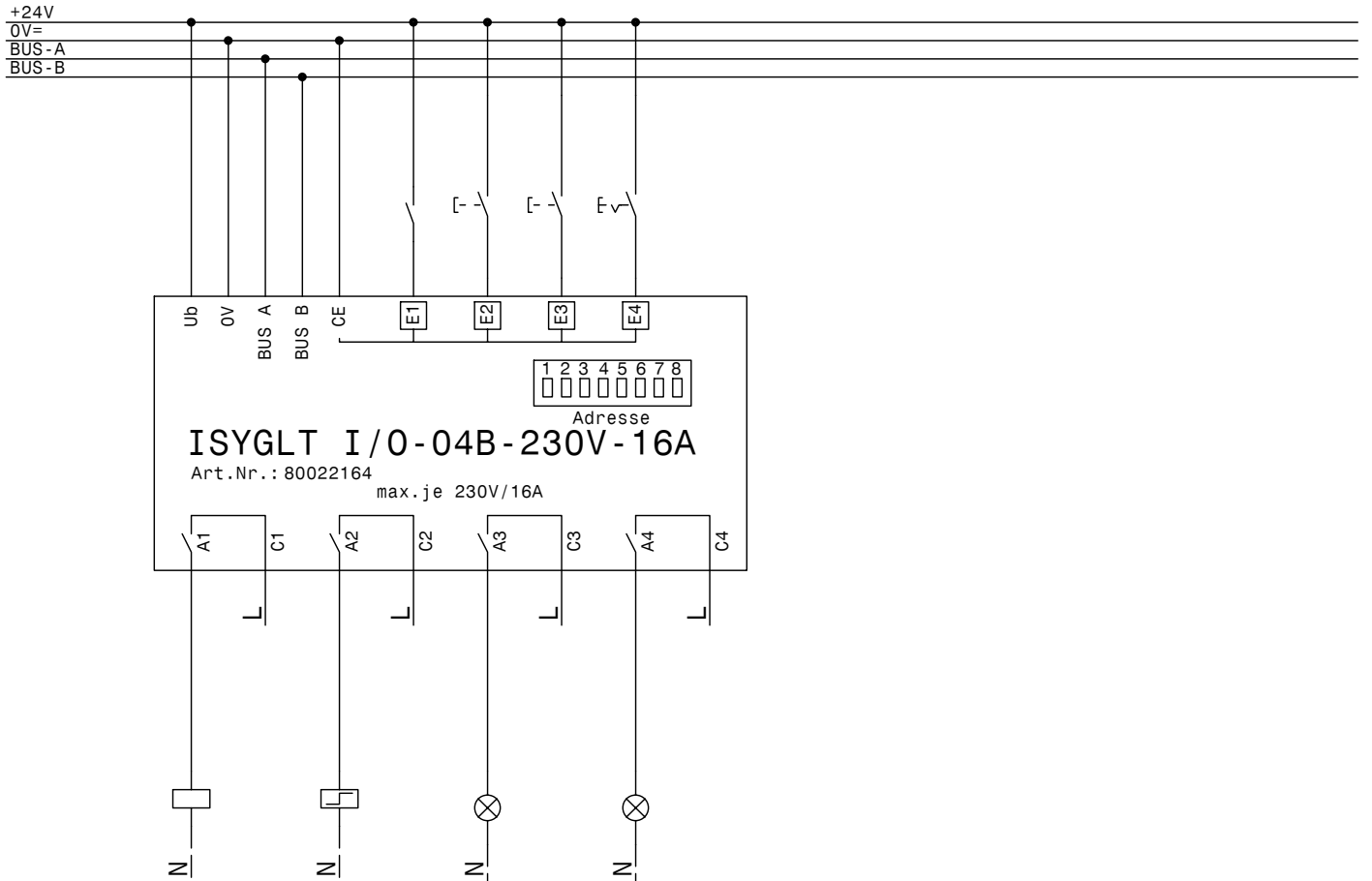

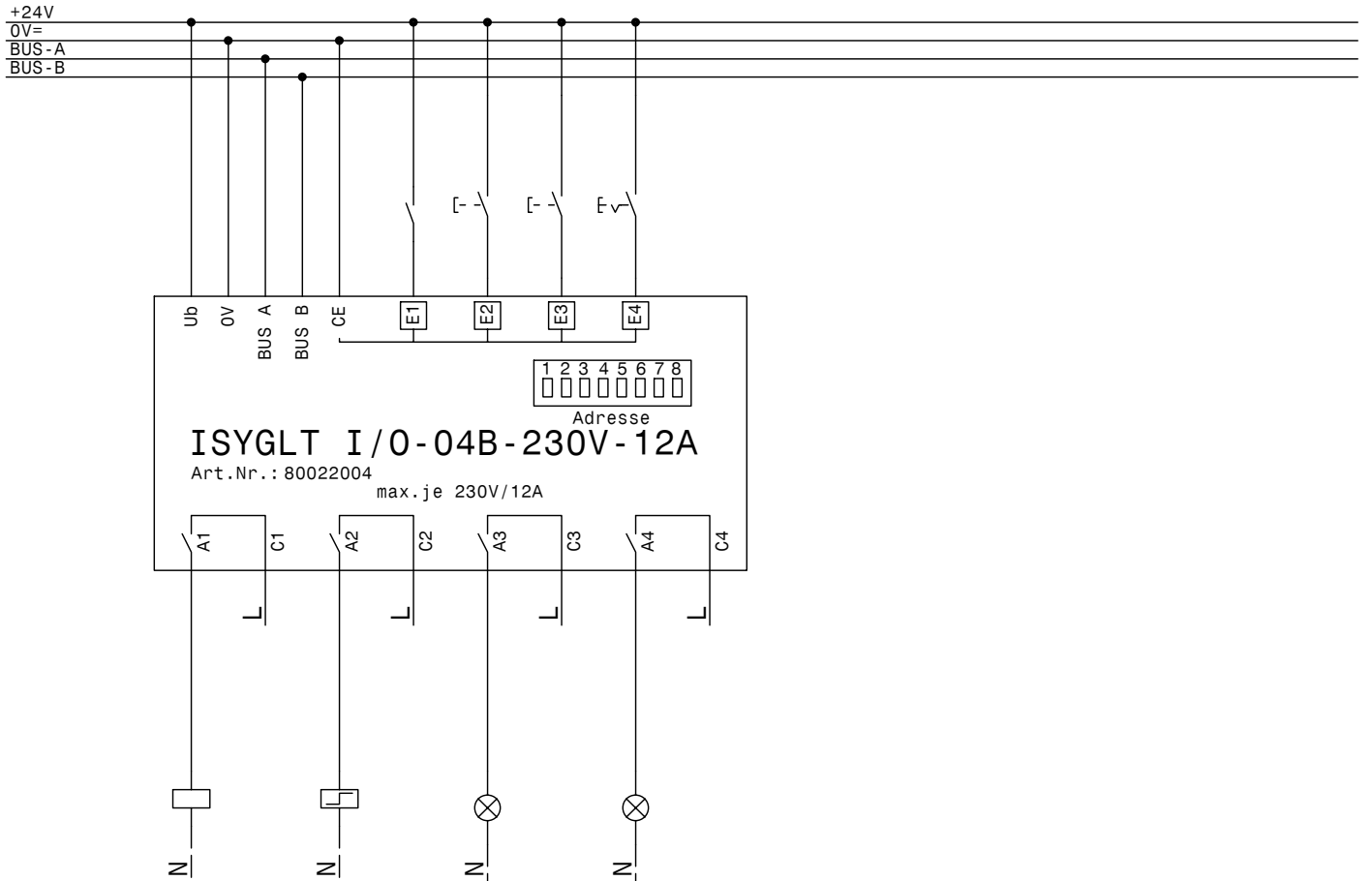

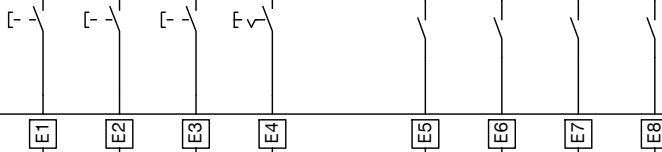

Havarie-Eingang

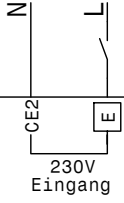

Achtung!
 Der Havarie-Eingang schaltet bei vorhandener Versorgungsspannung (24V) alle 8 Ausgänge ein!

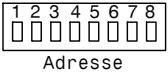

ISYGLT I/O-08B-230V - 16A

Art.-Nr.: 80022168 max. 230V/16A je Kontakt

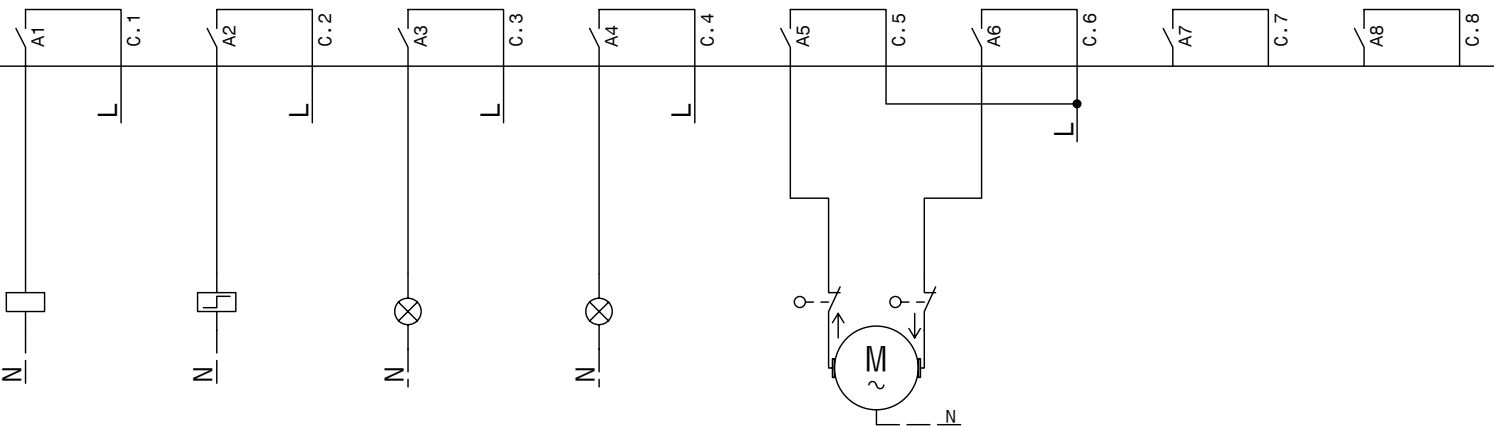

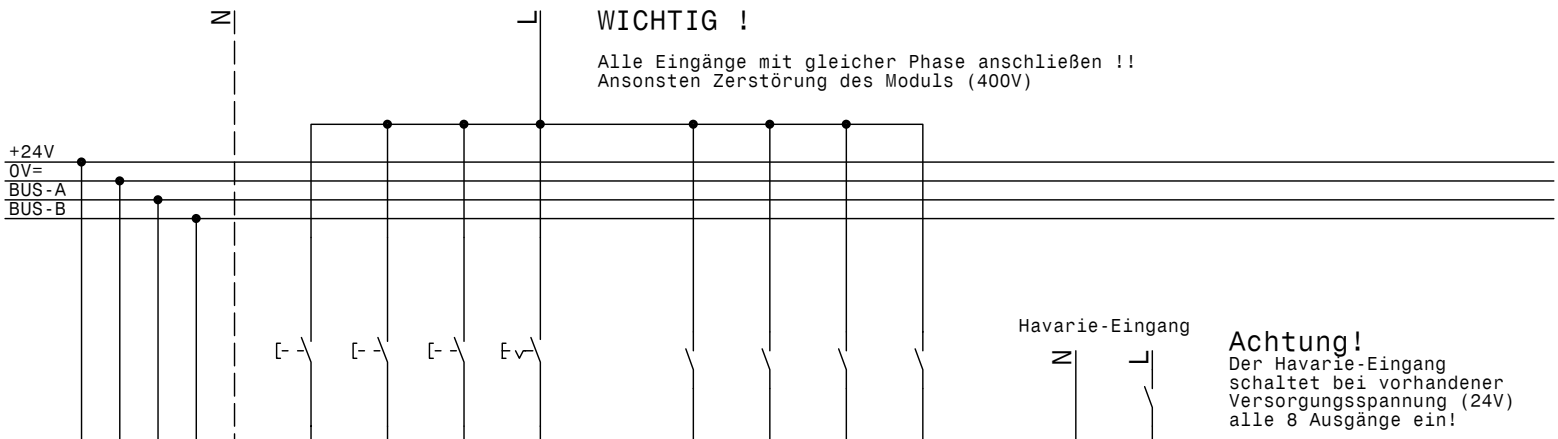

Achtung!
 Der Havarie-Eingang
 schaltet bei vorhandener
 Versorgungsspannung (24V)
 alle 8 Ausgänge ein!

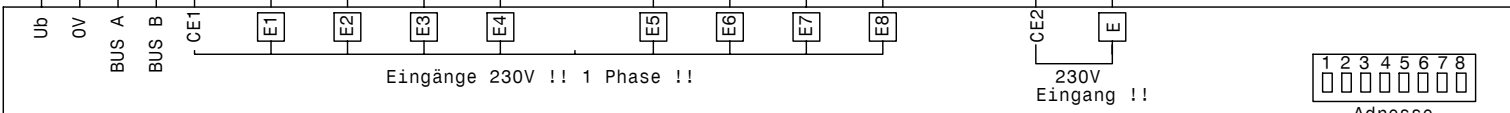

ISYGLT I/O-08C-230V - 16A

Art.-Nr.: 80022268 max. 230V/16A je Kontakt

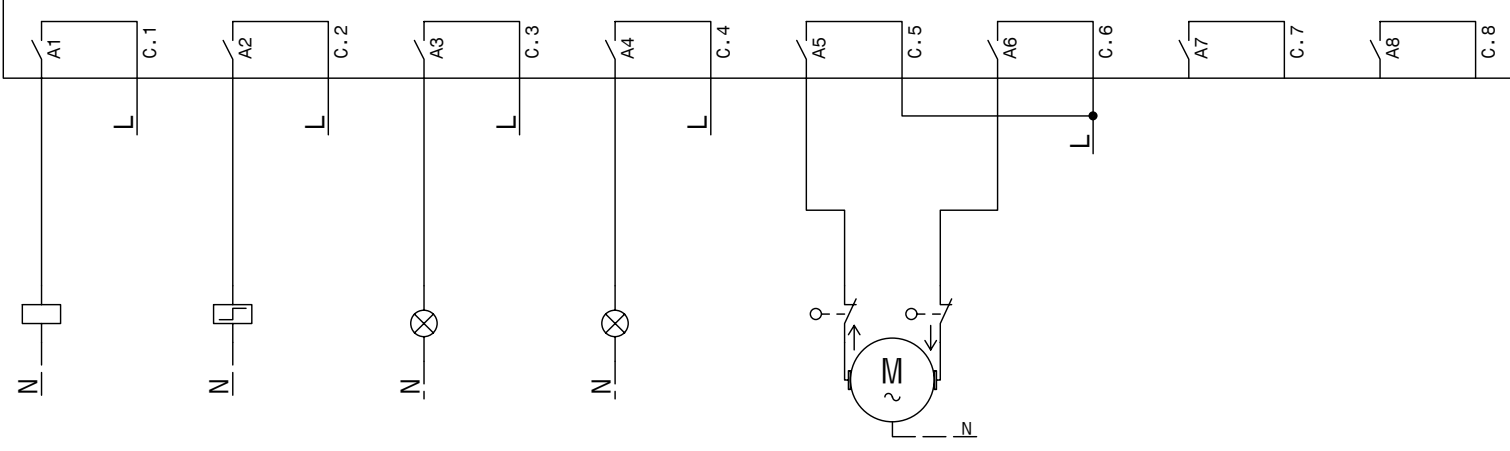

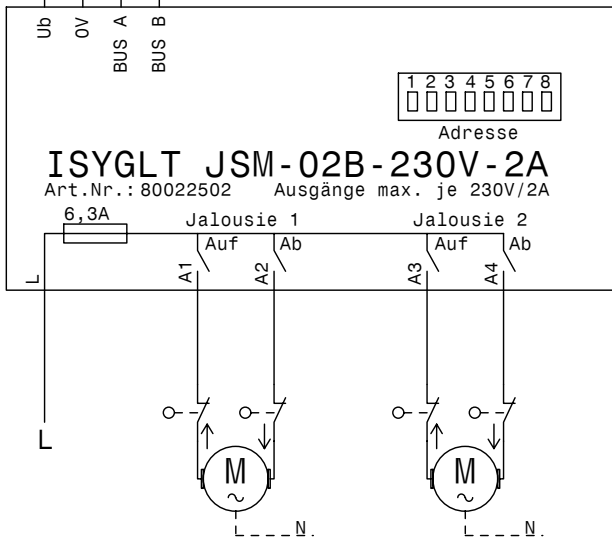
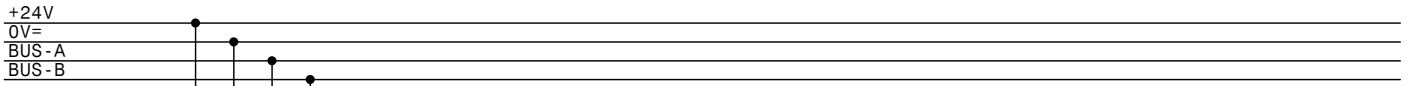

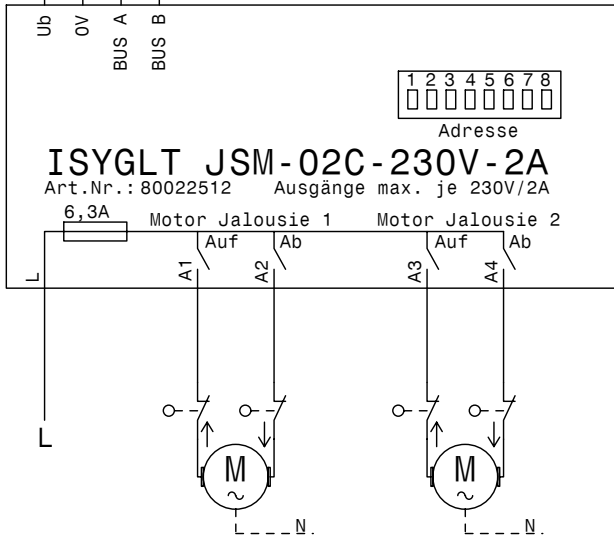
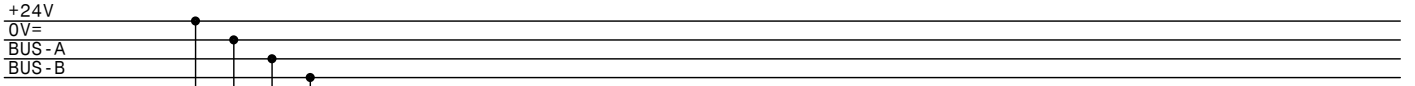

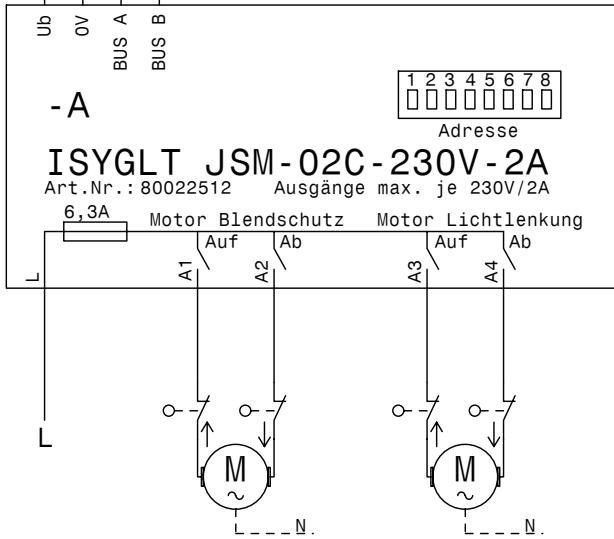
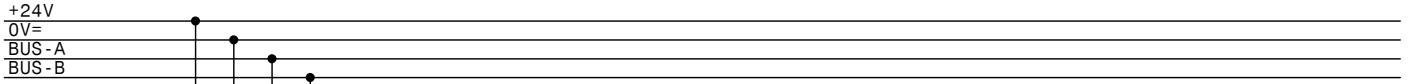

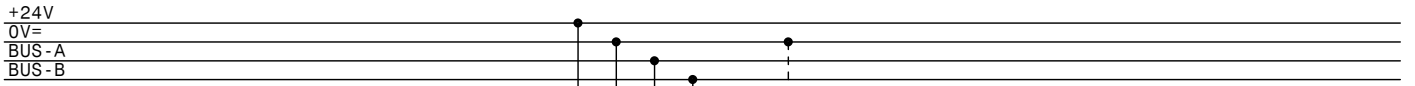

Achtung!
 Wenn der Havarie-Eingang "E" bei vorhandener
 Versorgungsspannung (24V) auf 0V gelegt wird,
 steuern alle Ausgänge auf 10V!

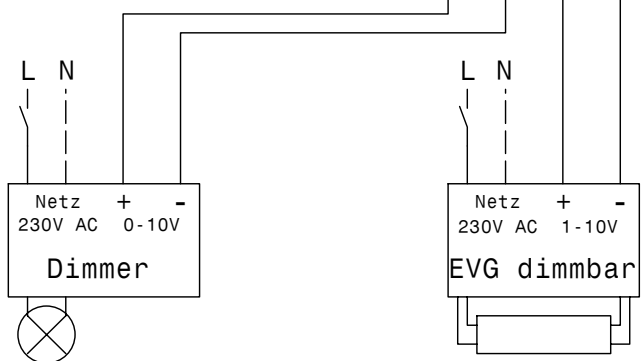
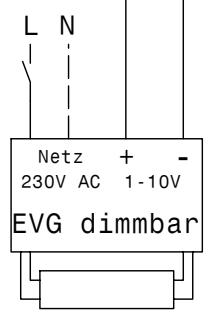
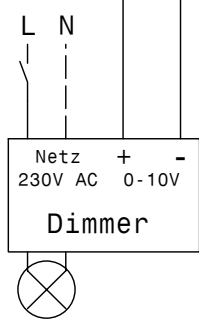
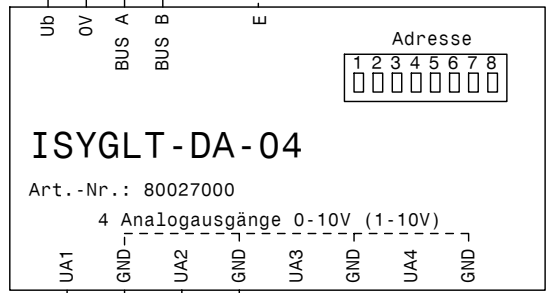

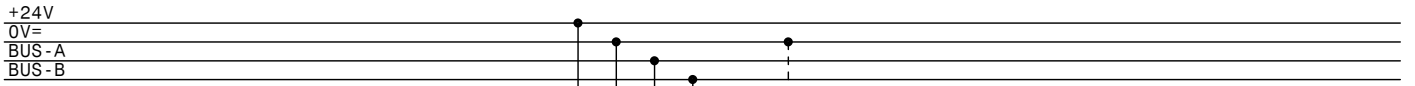

Achtung!
Wenn der Havarie-Eingang "E" bei vorhandener
Versorgungsspannung (24V) auf 0V gelegt wird,
steuern alle Ausgänge auf 10V!

Ub 0V BUS A BUS B E

Adresse
1 2 3 4 5 6 7 8
□ □ □ □ □ □ □ □

ISYGLT-DA-04-V2

Art.-Nr.: 80027002

4 Analogausgänge 0-10V (1-10V)

UA1 GND UA2 GND UA3 GND UA4 GND

L N

Netz + -
230V AC 0-10V

Dimmer

L N

Netz + -
230V AC 1-10V

EVG dimmbar

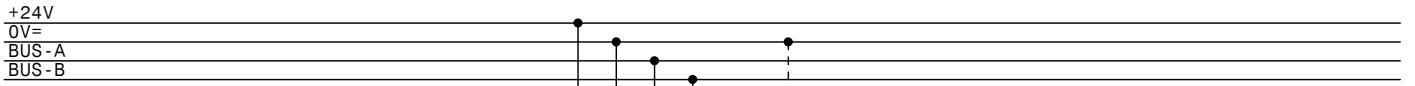

Achtung!
Wenn der Havarie-Eingang "E" bei vorhandener
Versorgungsspannung (24V) auf 0V gelegt wird,
steuern alle Ausgänge auf 10V!

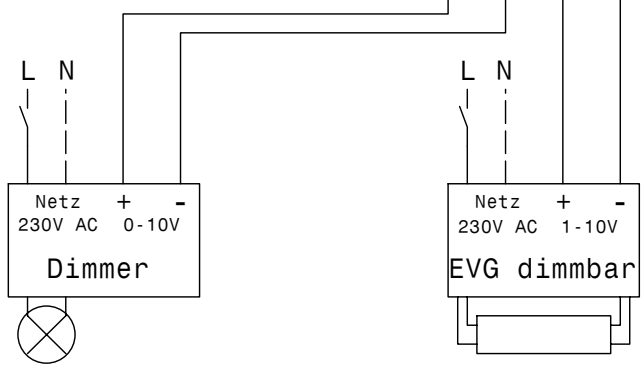
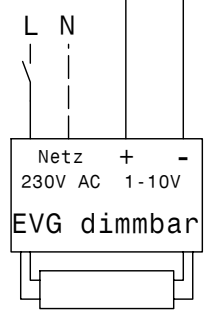
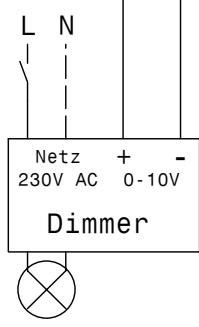
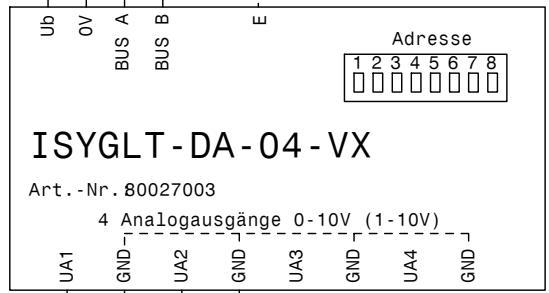

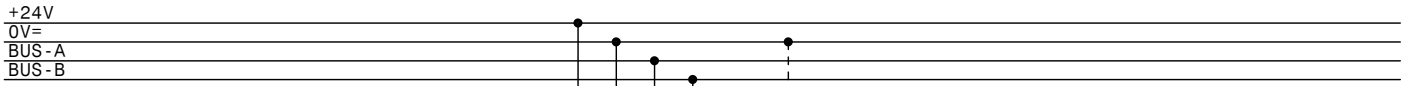

Achtung!
 Wenn der Havarie-Eingang "E" bei vorhandener
 Versorgungsspannung (24V) auf 0V gelegt wird,
 steuern alle Ausgänge auf 10V!

Ub 0V BUS A BUS B E

Adresse
 1 2 3 4 5 6 7 8
 □ □ □ □ □ □ □ □

ISYGLT-DA-04-VM2
 Art.-Nr.: 80027004
 4 Analogausgänge 0-10V (1-10V)

UA1 GND UA2 GND UA3 GND UA4 GND

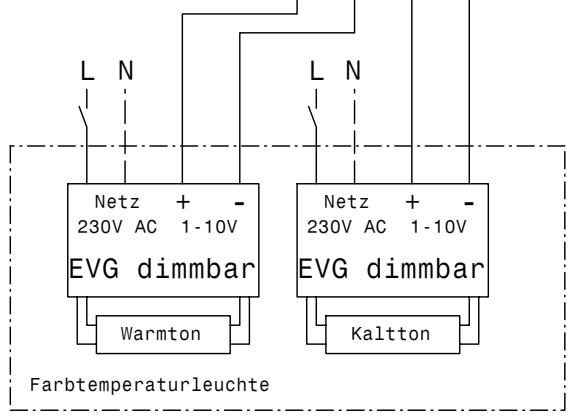

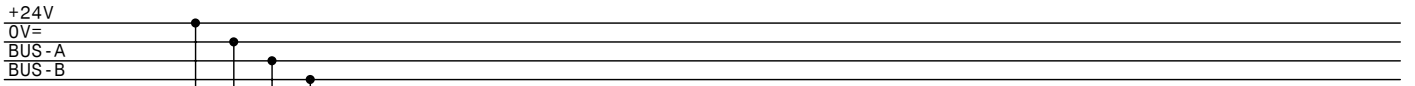

Ub
0V
BUS A
BUS B

Adresse
1 2 3 4 5 6 7 8
□ □ □ □ □ □ □ □

ISYGLT - VOL - 04B - log47k

Art.-Nr.: 80027050

4 elektron. Poti log47k

H1 W1 L1 H2 W2 L2 H3 W3 L3 H4 W4 L4

L R

CD-Player

L IN R IN

Verstärker

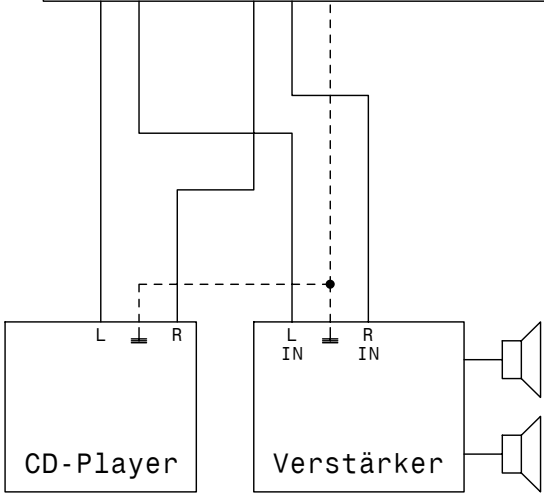

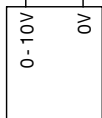
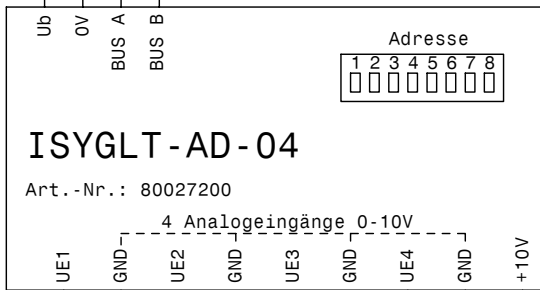
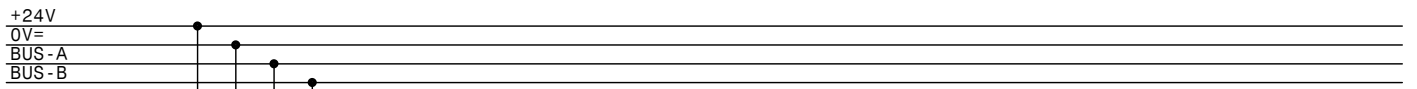

externer Geber

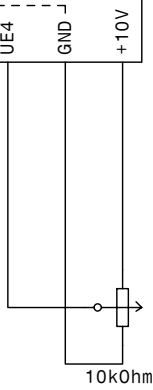

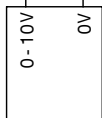
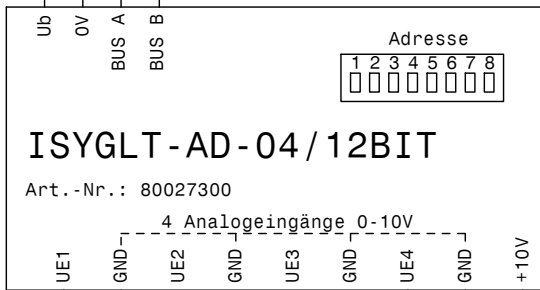
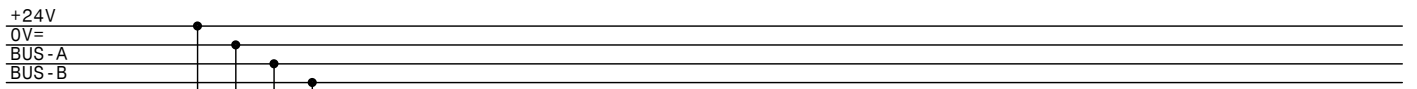

externer Geber

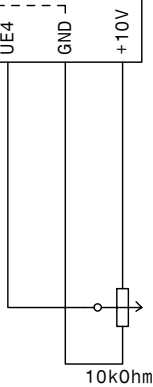

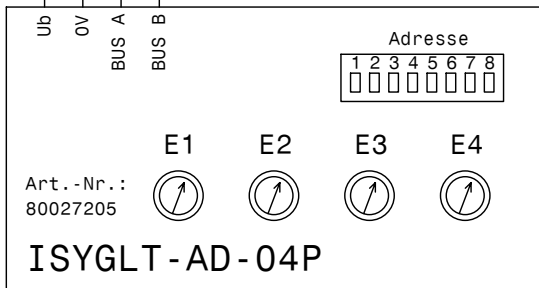
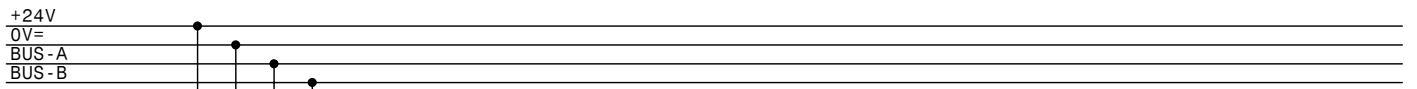

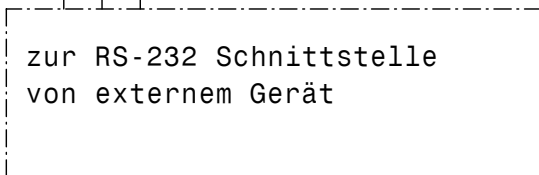
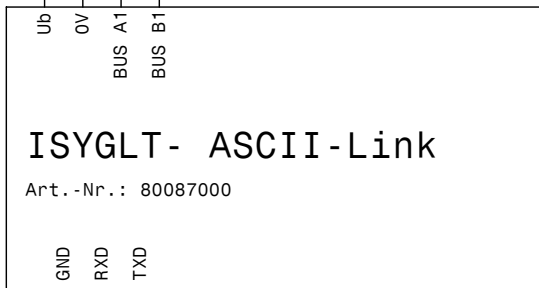
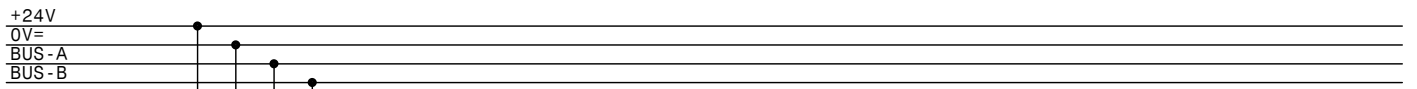

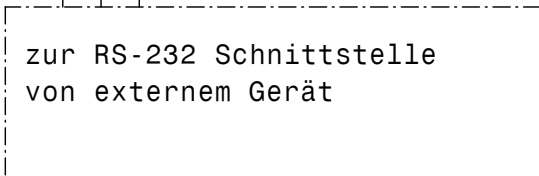
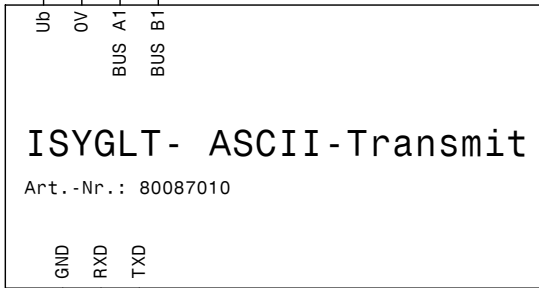
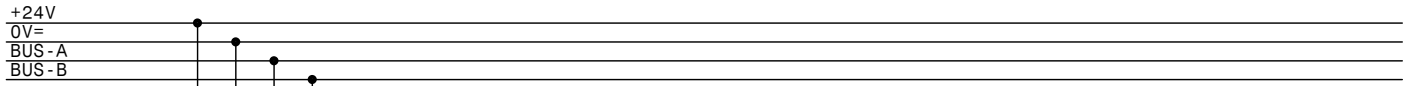

+24V
 0V=
 BUS-A
 BUS-B

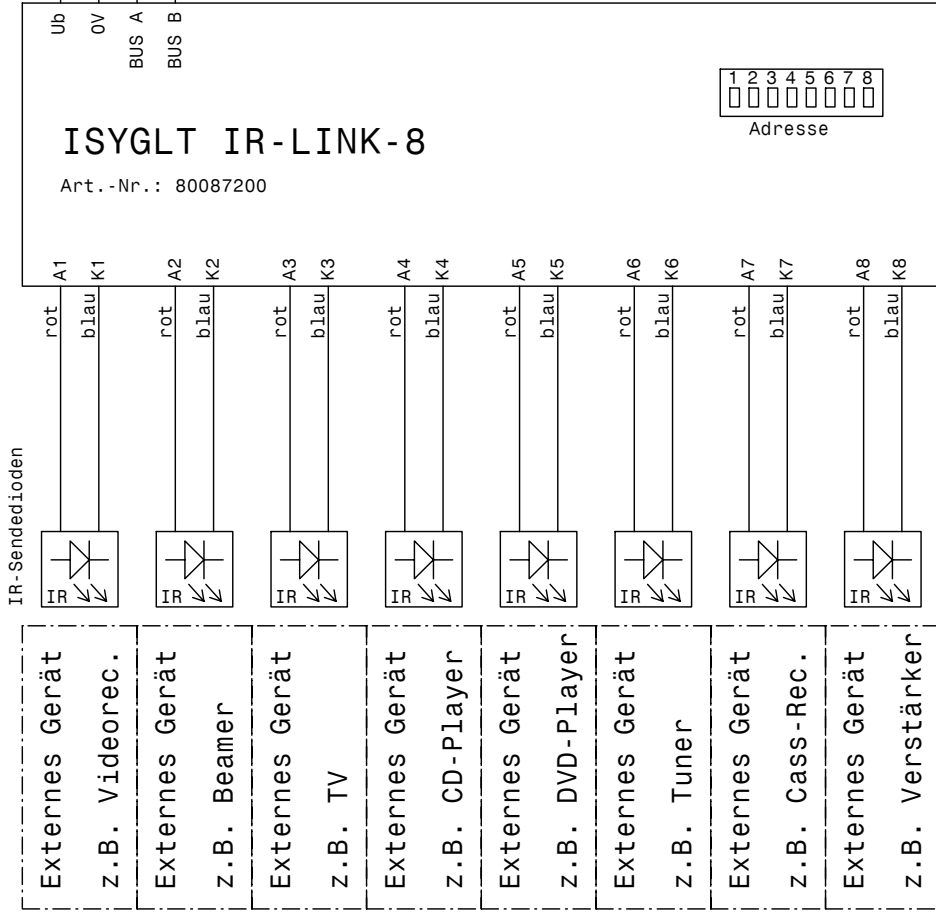

+24V
0V=
BUS-A
BUS-B

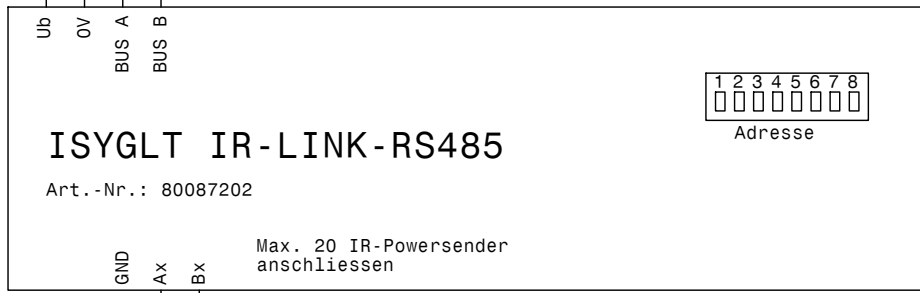

zu weiteren
IR-Powersendern
(max. 20)

+24V
0V=
Ax
Bx

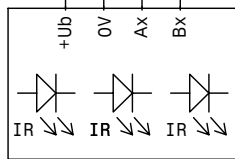

ISYGLT
IR-Powersender
Art.-Nr.: 80087203

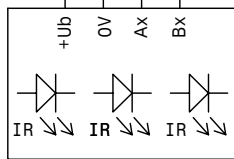

ISYGLT
IR-Powersender
Art.-Nr.: 80087203

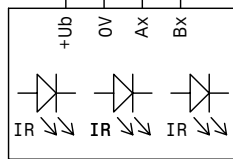

ISYGLT
IR-Powersender
Art.-Nr.: 80087203

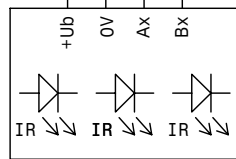

ISYGLT
IR-Powersender
Art.-Nr.: 80087203

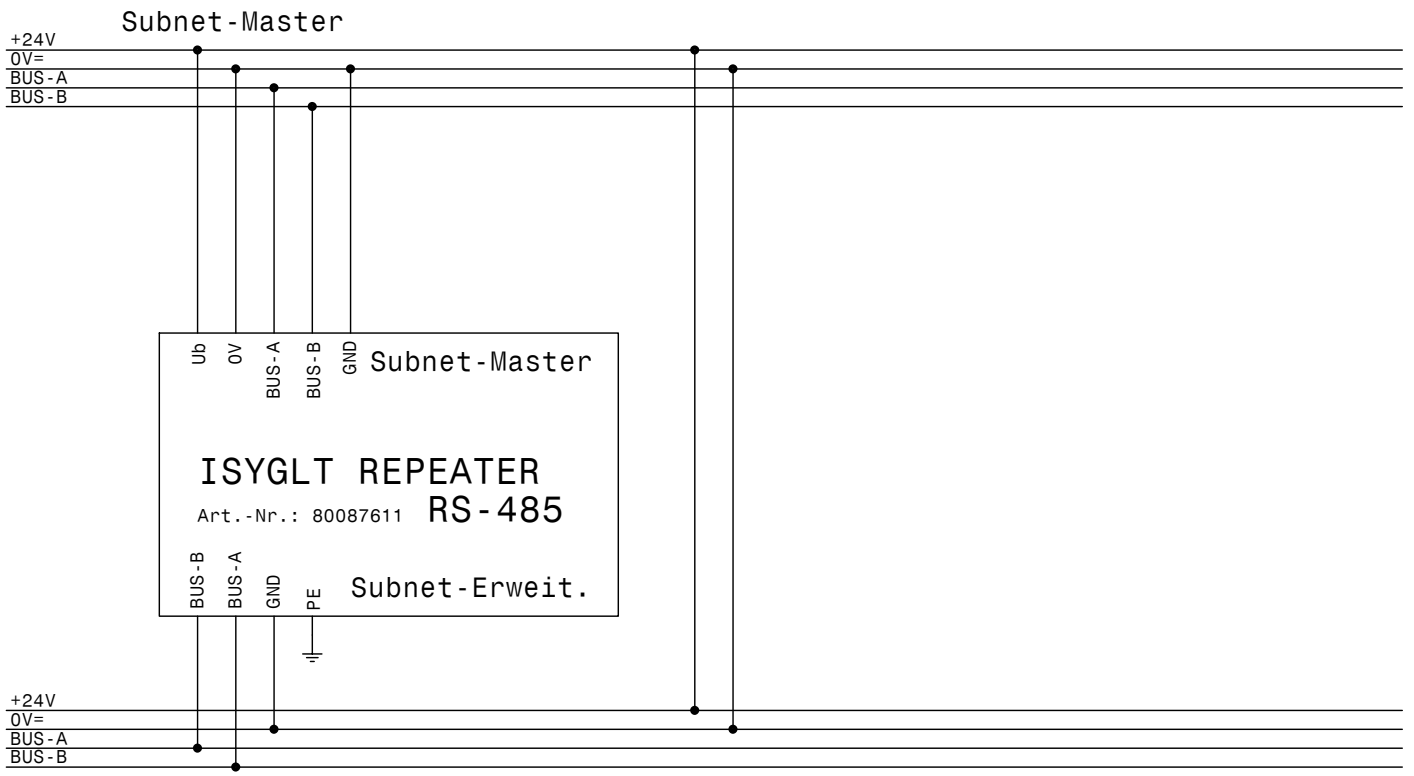

Subnet-Erweiterung ohne galvanische Trennung

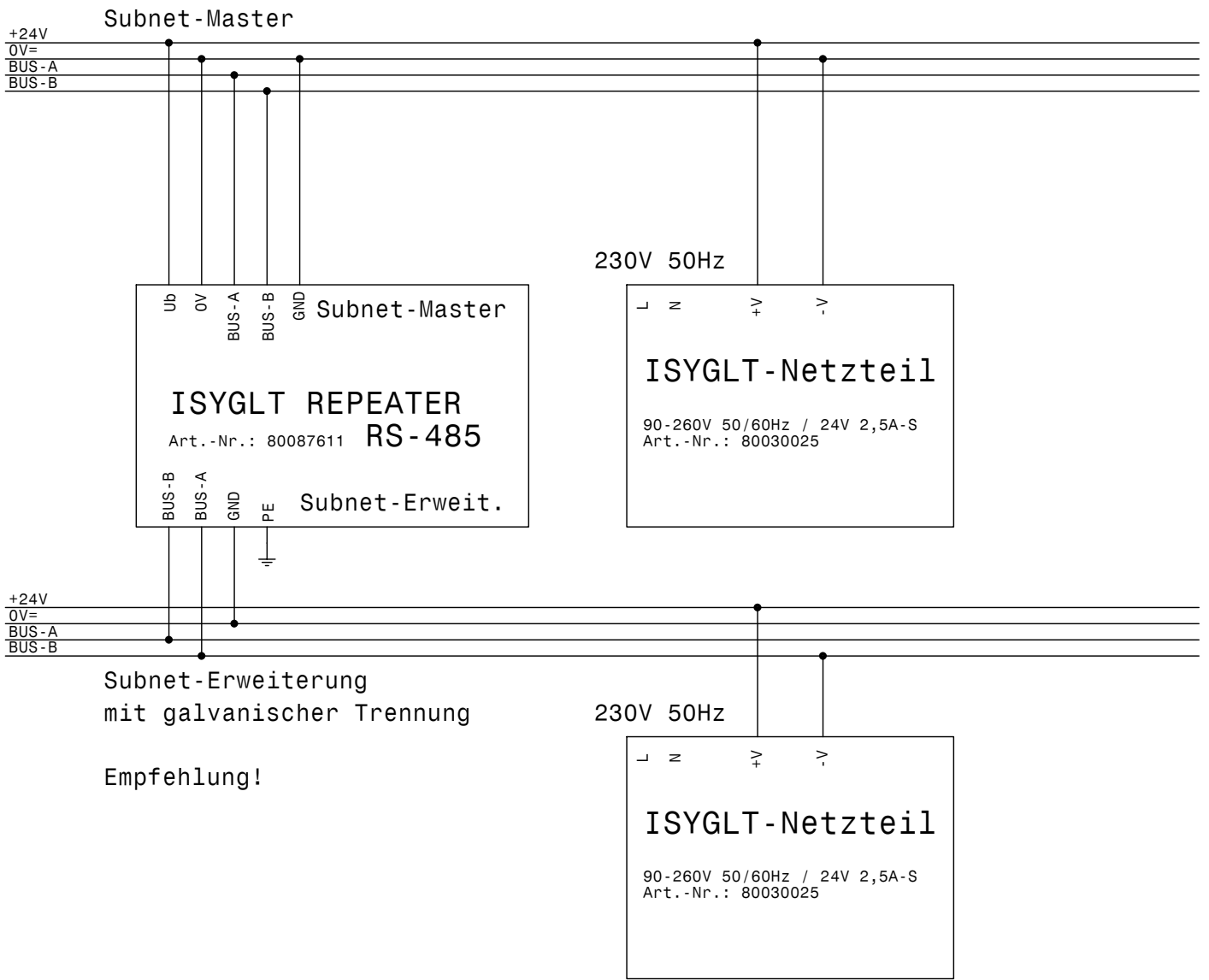

Subnet-Master

+24V
0V=
BUS-A
BUS-B

Ub 0V BUS-A BUS-B GND Subnet-Master

ISYGLT REPEATER
Art.-Nr.: 80087611 **RS-485**

BUS-B BUS-A GND PE Subnet-Erweit.

230V 50Hz

L N PE GND

ISYGLT-Netzteil
90-260V 50/60Hz / 24V 2,5A-S
Art.-Nr.: 80030025

+24V
0V=
BUS-A
BUS-B

Subnet-Erweiterung
mit galvanischer Trennung

230V 50Hz

L N PE GND

ISYGLT-Netzteil
90-260V 50/60Hz / 24V 2,5A-S
Art.-Nr.: 80030025

Empfehlung!

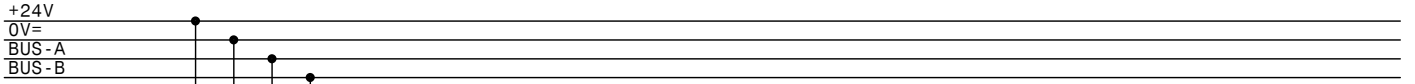

Drehschalter
im Gehäuse

- 0 = 2s
- 1 = 10s
- 2 = 20s
- 3 = 30s
- 4 = 40s
- 5 = 50s
- 6 = 60s
- 7 = 70s
- 8 = 80s
- 9 = 90s

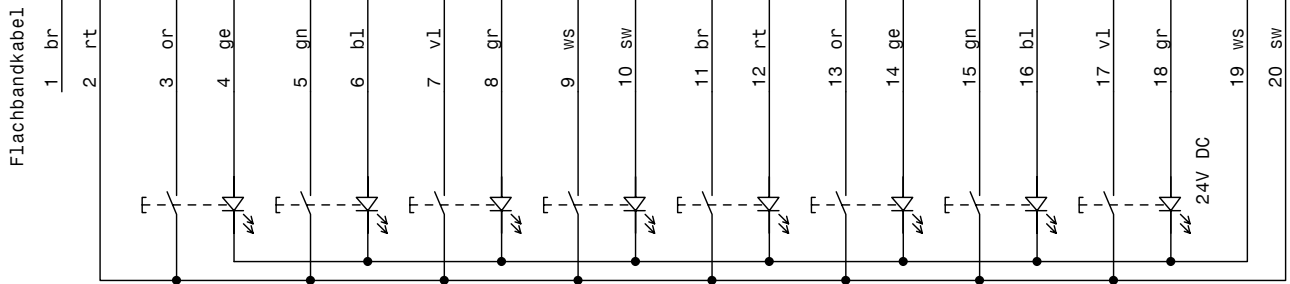
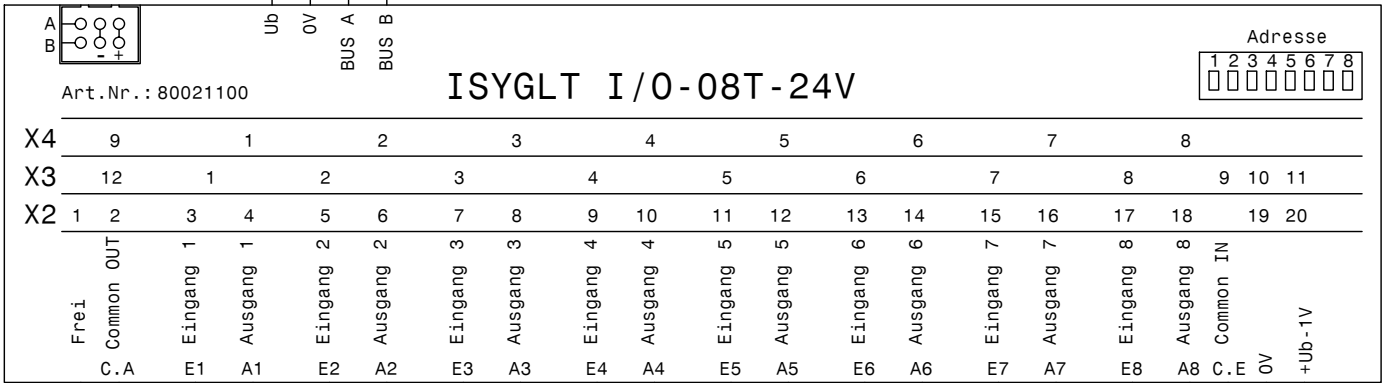
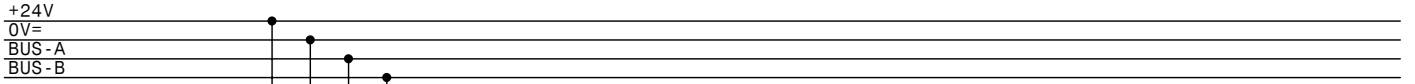

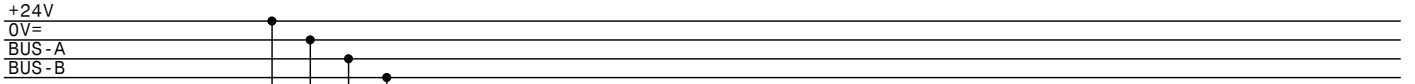

Ub
 0V
 BUS A
 BUS B

Art.Nr. : 80021150

ISYGLT I/O-08T-PNP

Adresse

1	2	3	4	5	6	7	8
□	□	□	□	□	□	□	□

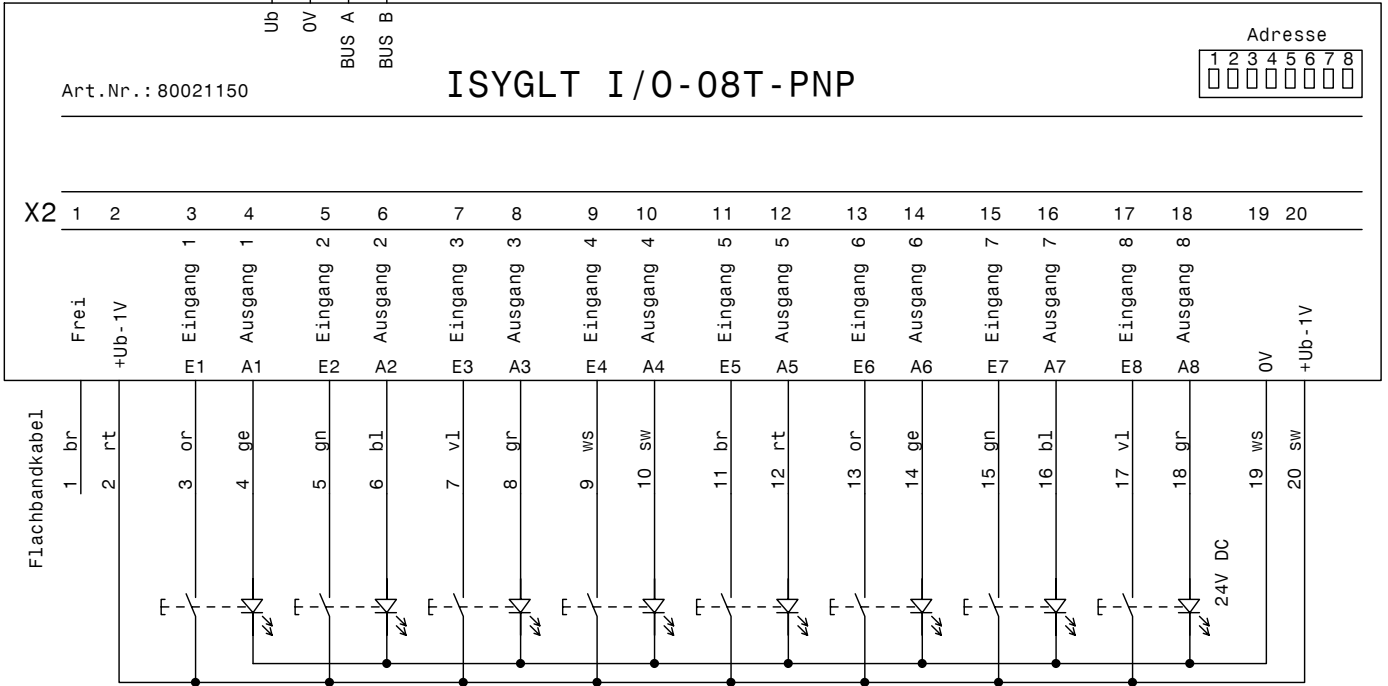

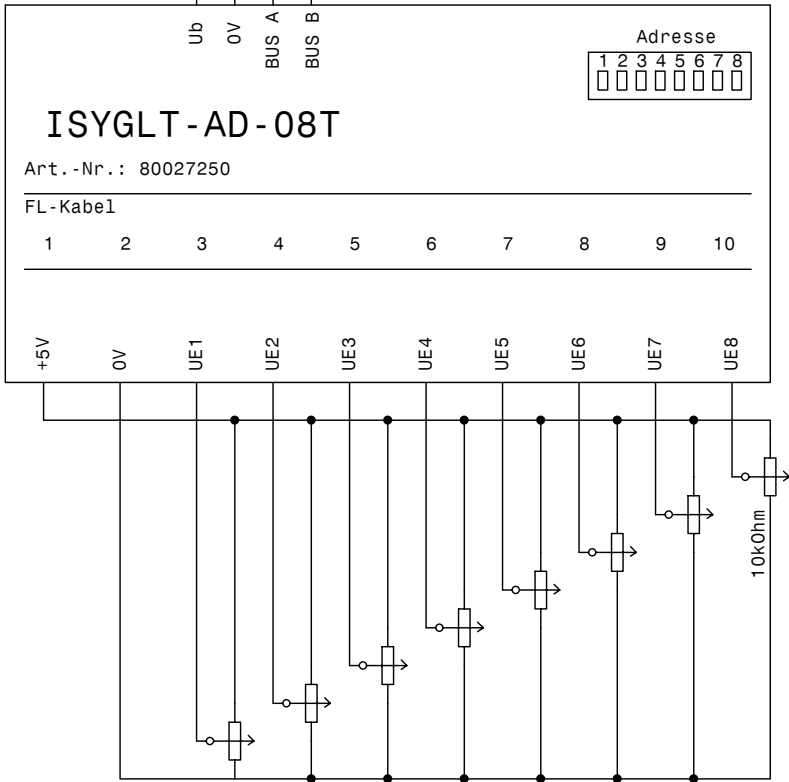
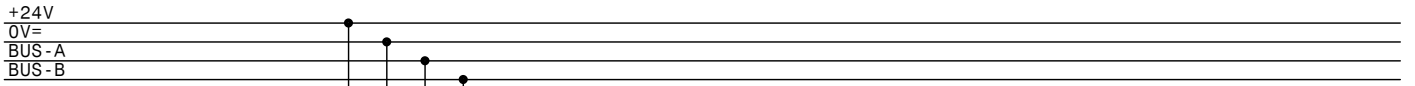

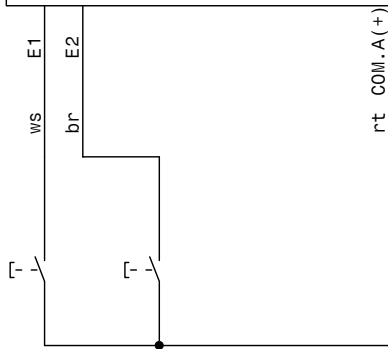
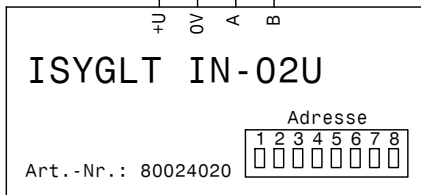
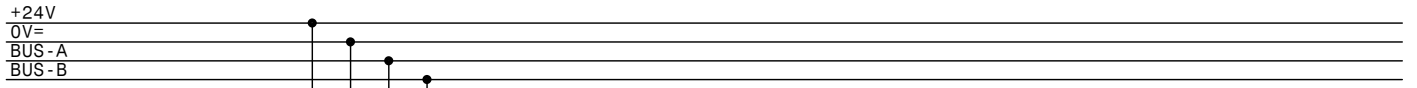

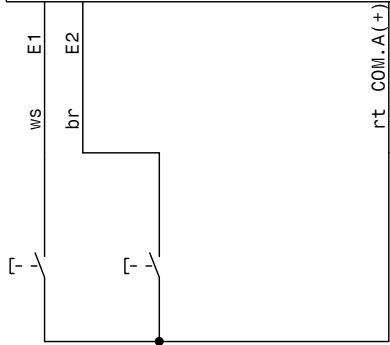
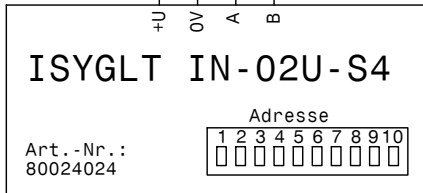
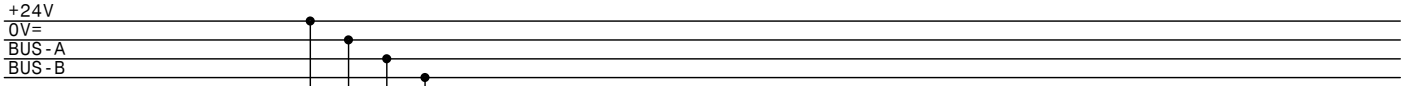

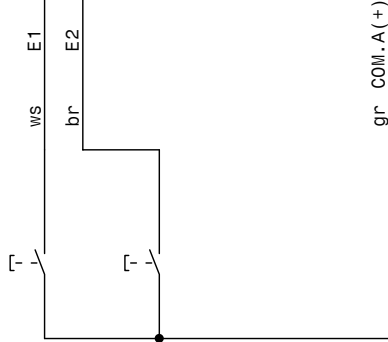
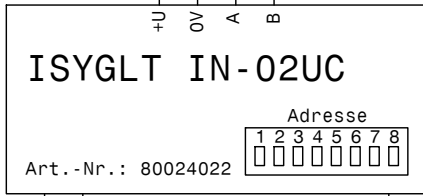
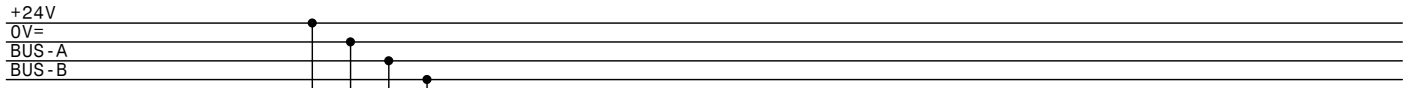

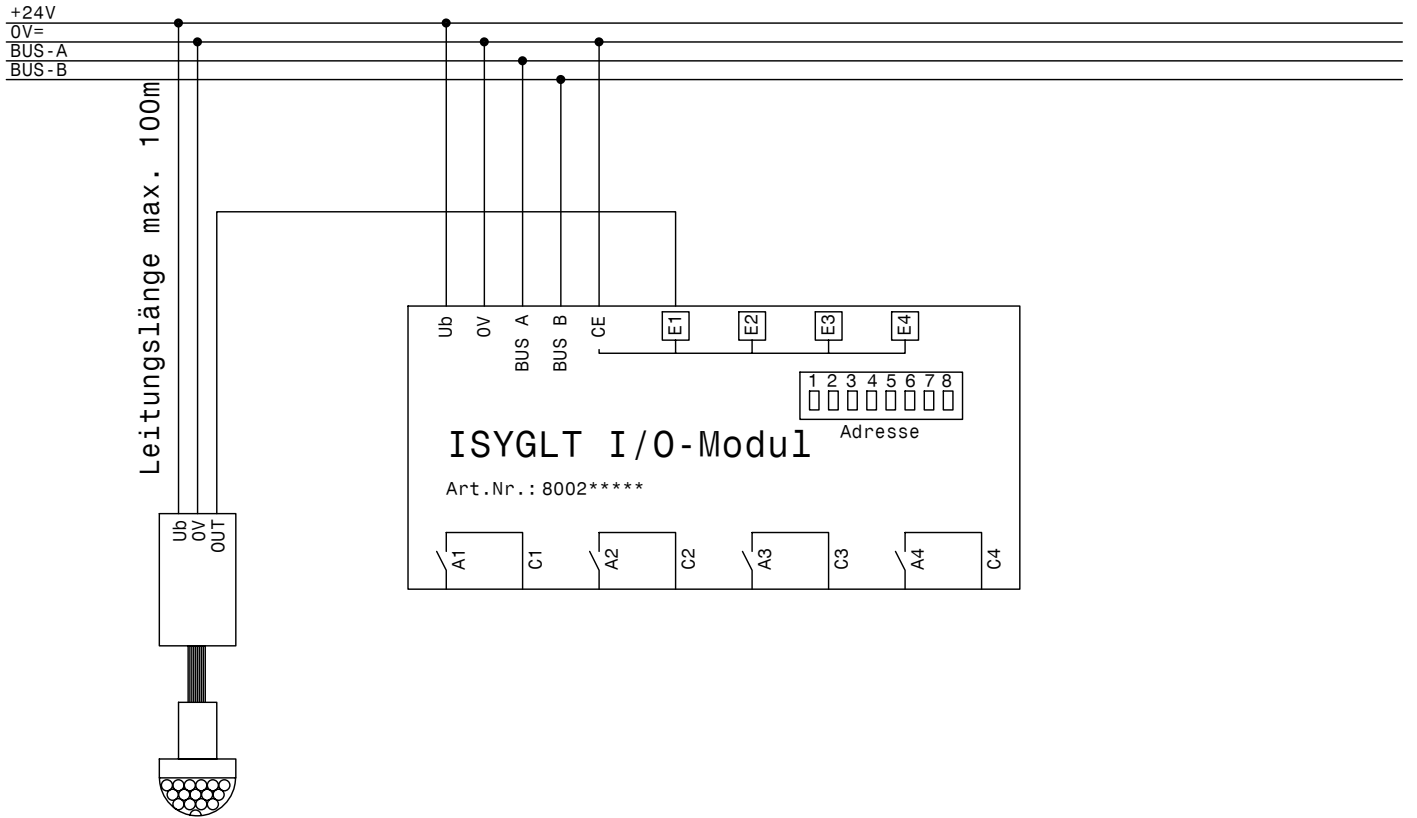

Art.Nr.: 80087152
Bewegungswächter
 ISYGLT BW-02

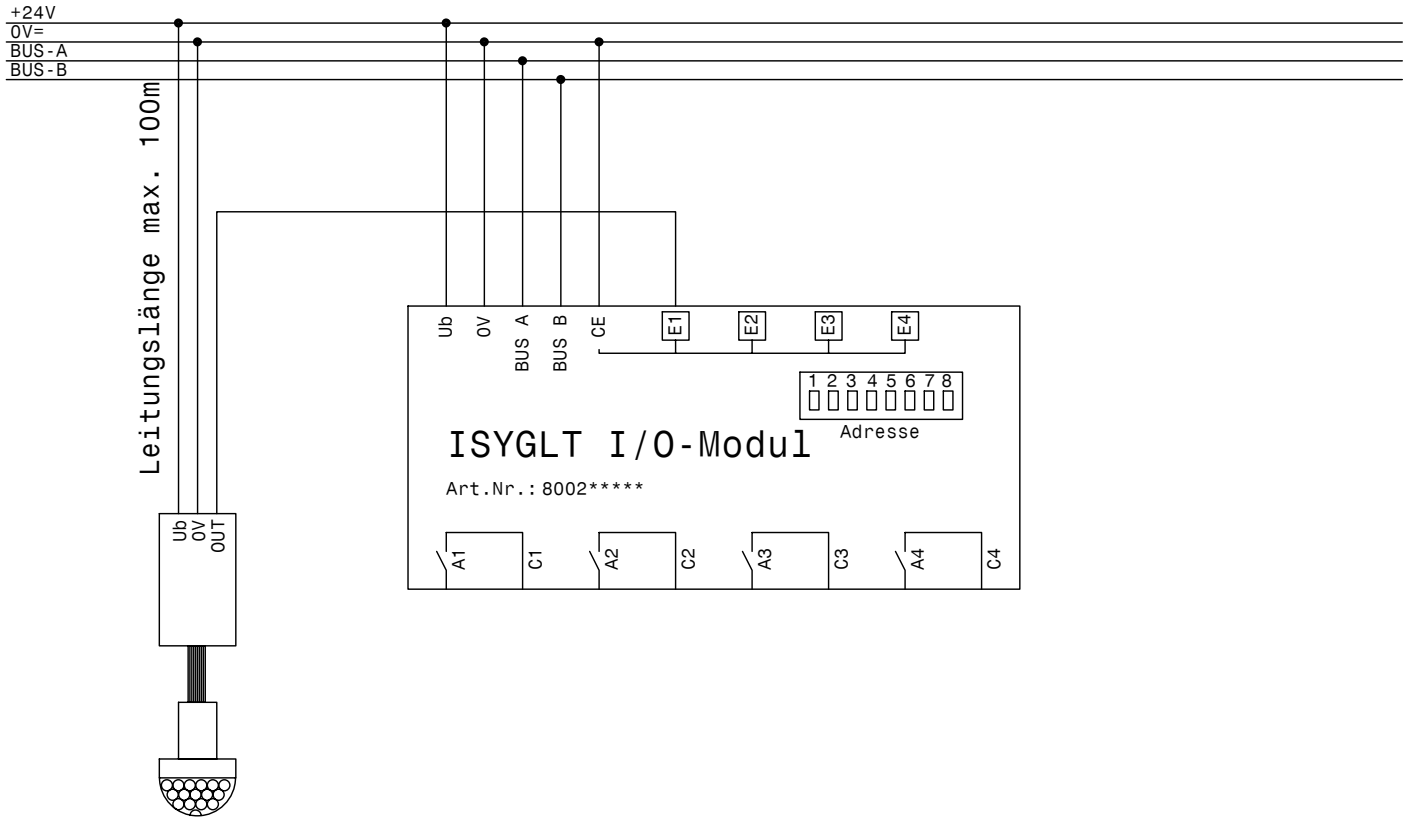

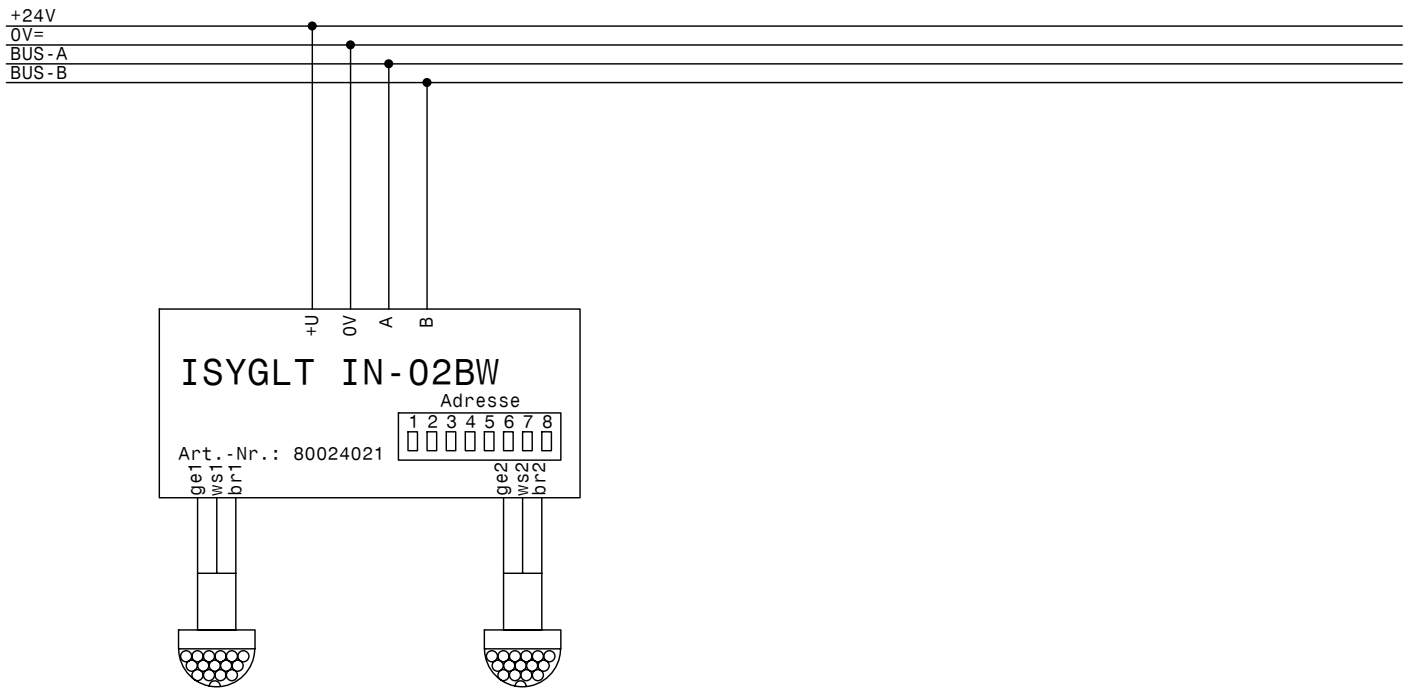

Art.Nr.: 8008715*
 Bewegungswächter
 ISYGLT BW-01

Art.Nr.: 8008715*
 Bewegungswächter
 ISYGLT BW-01

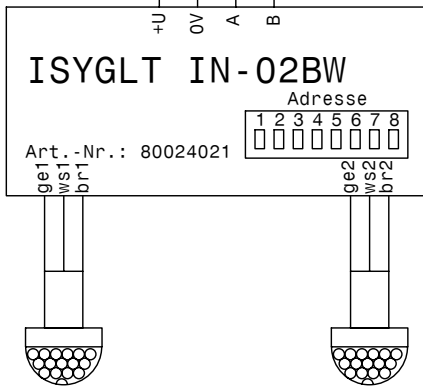
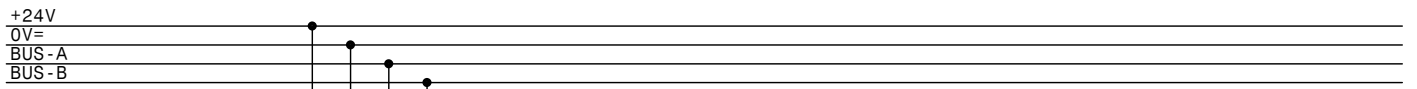

Art.Nr.: 8008718*
 Bewegungswächter
 ISYGLT BW-04

Art.Nr.: 8008718*
 Bewegungswächter
 ISYGLT BW-04

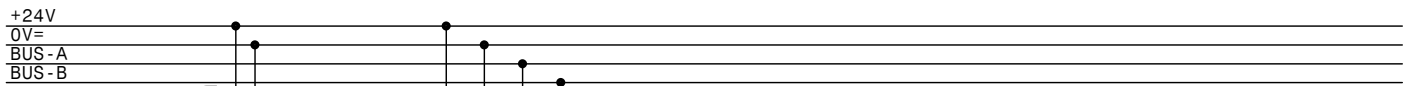

Leitungslänge max. 100m

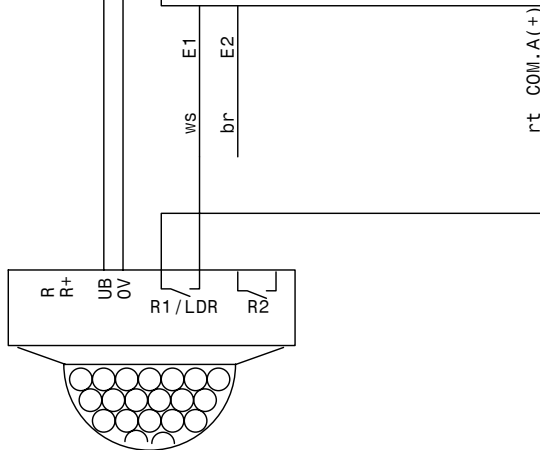
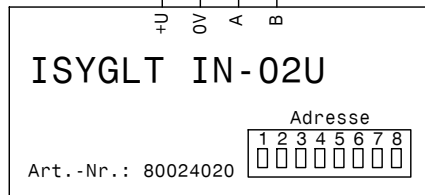

Art.Nr.: 8008402*

Presensensor
 ISYGLT BW2-PR-XX

Relais 1: Lichtwert+Bewegung
 Relais 2: Bewegung

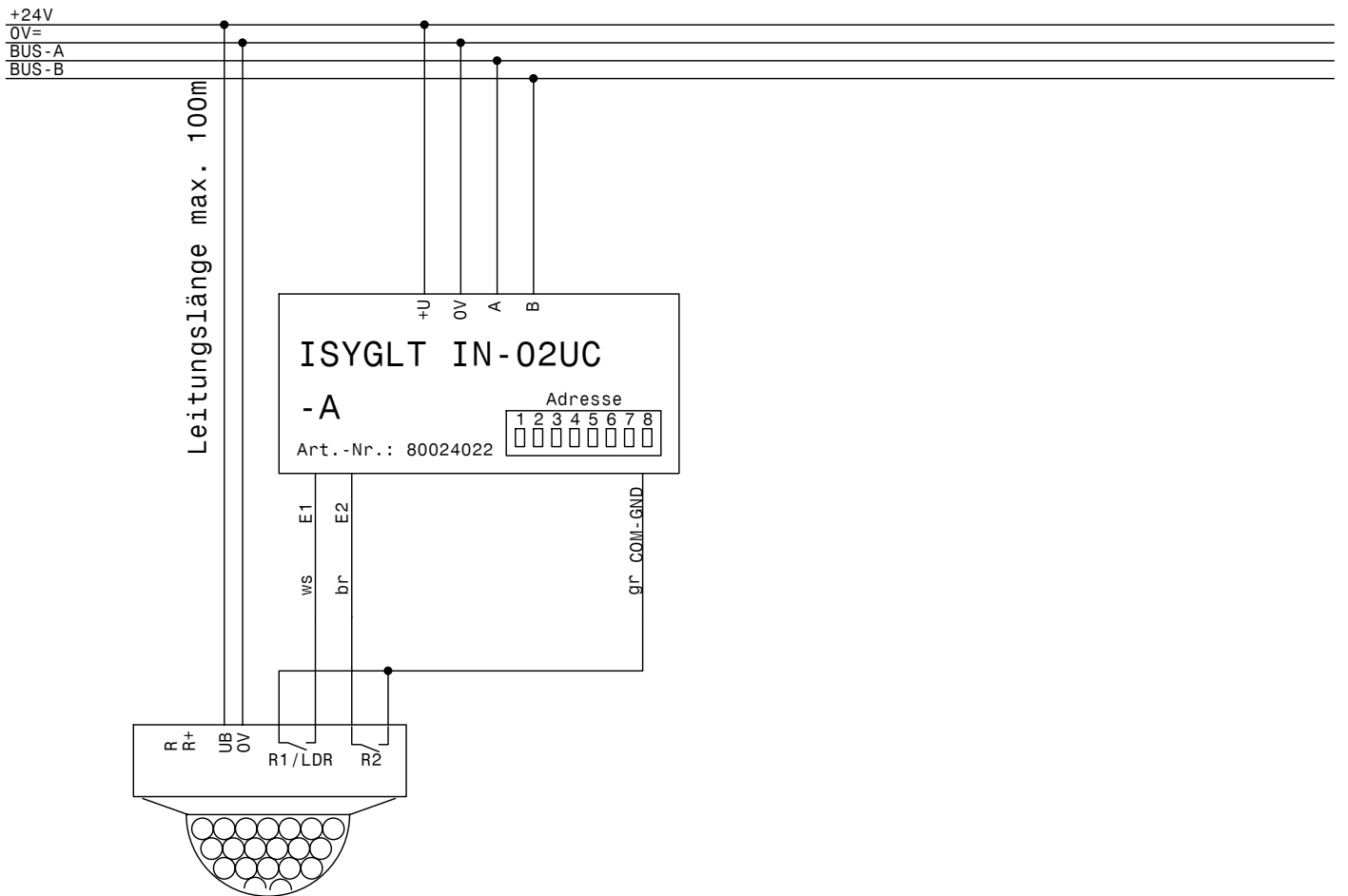

Presensensor
 ISYGLT BW2-PR-XX

Relais 1: Lichtwert+Bewegung
 Relais 2: Bewegung

+24V
 0V=
 BUS-A
 BUS-B

Leitungslänge max. 100m

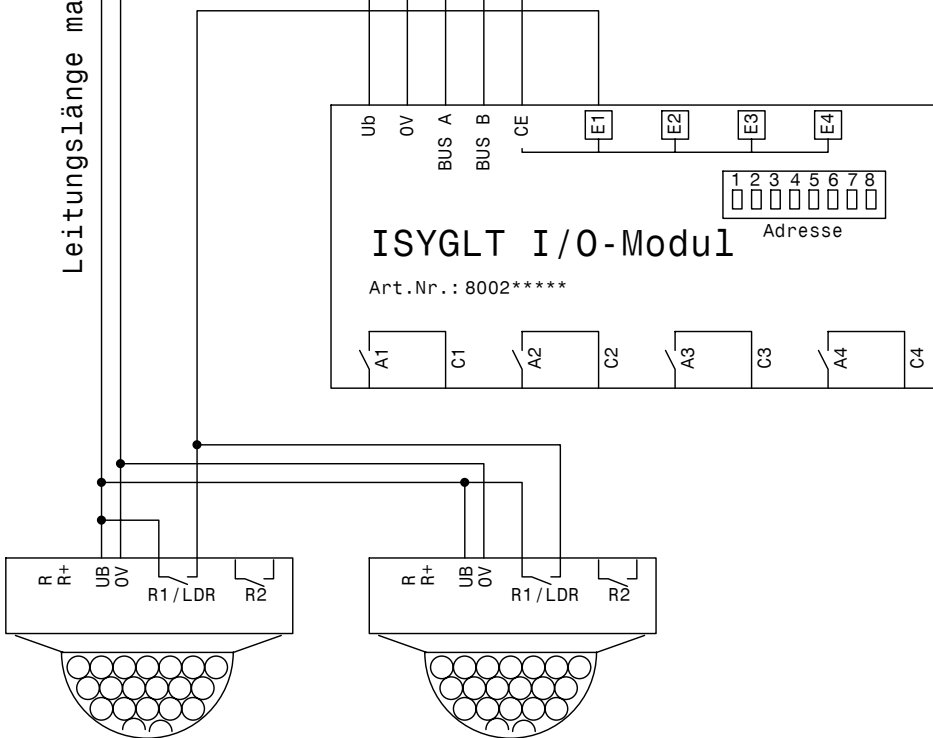

Art.Nr.: 8008402*
 Presensensor
 ISYGLT BW2-PR-XX

Art.Nr.: 8008402*
 Presensensor
 ISYGLT BW2-PR-XX

Relais 1: Lichtwert+Bewegung
 Relais 2: Bewegung

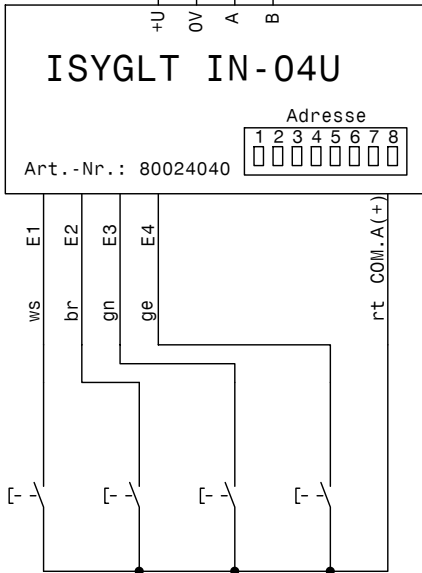
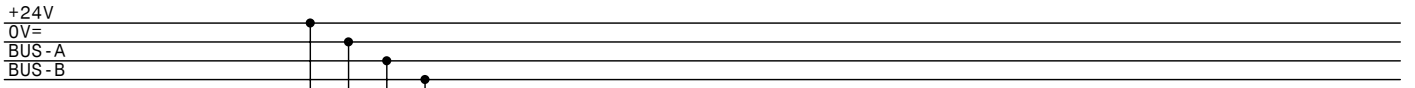

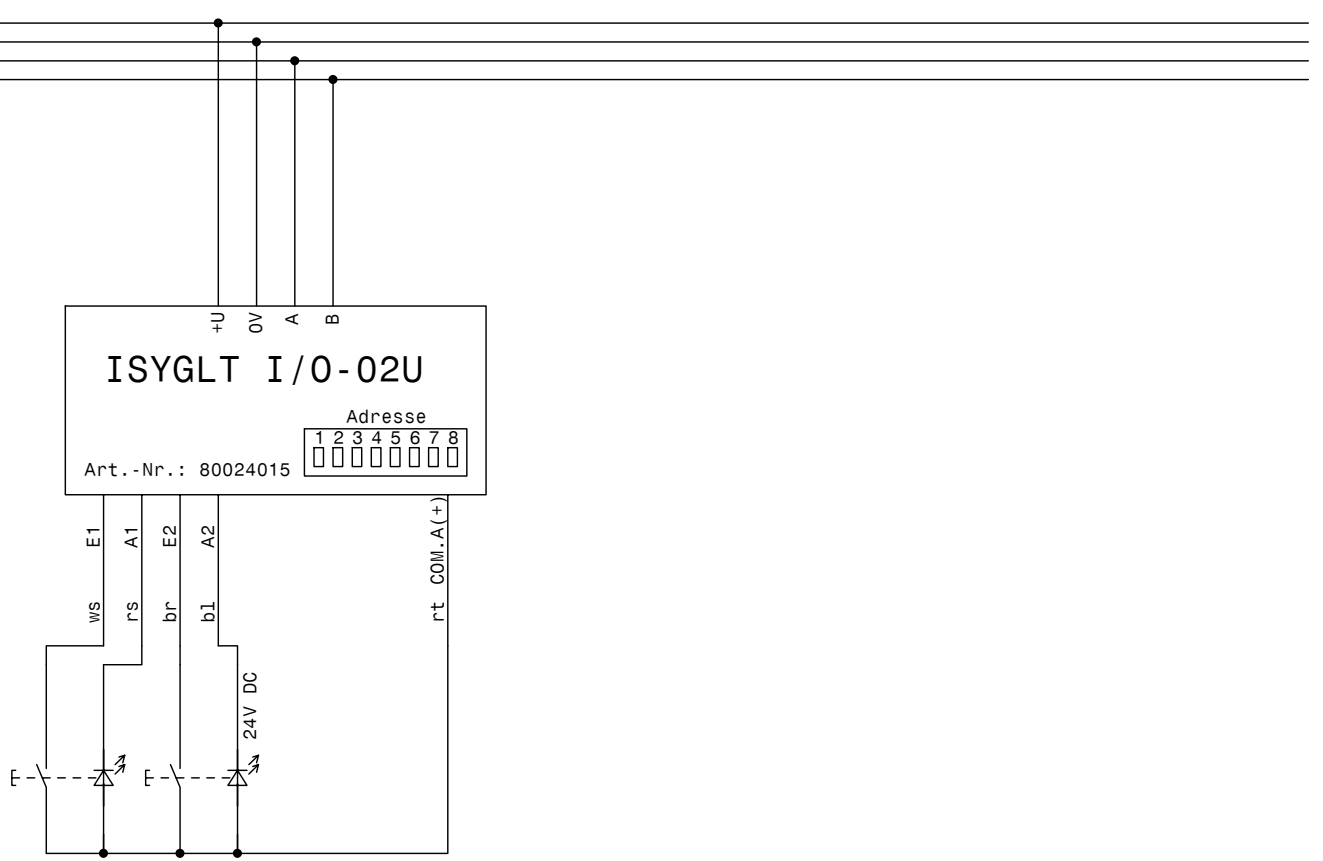
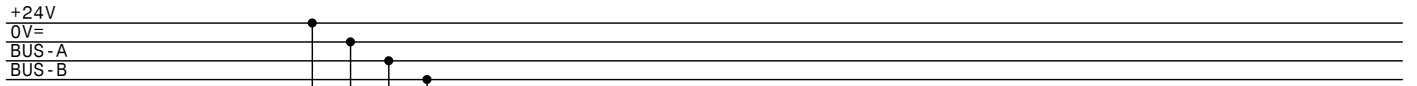

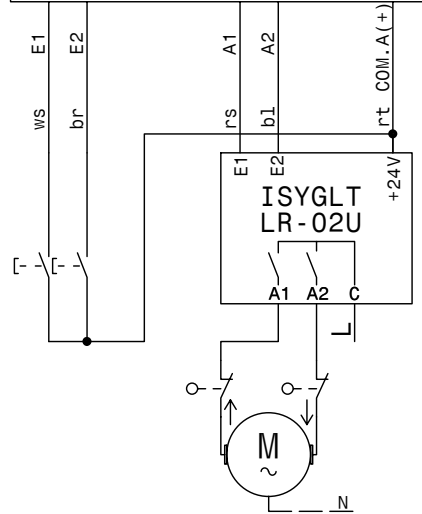
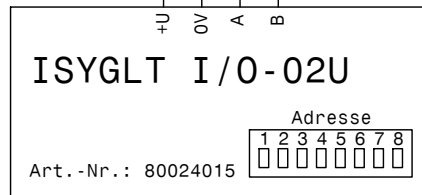
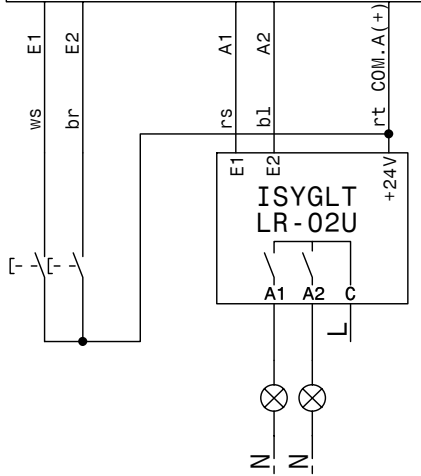
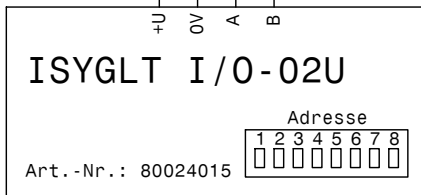
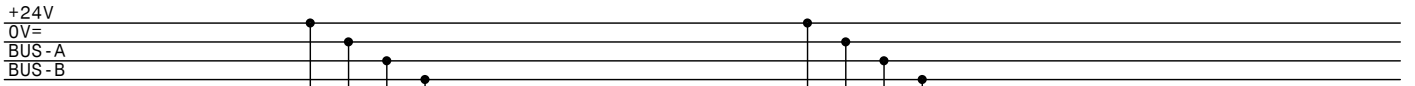

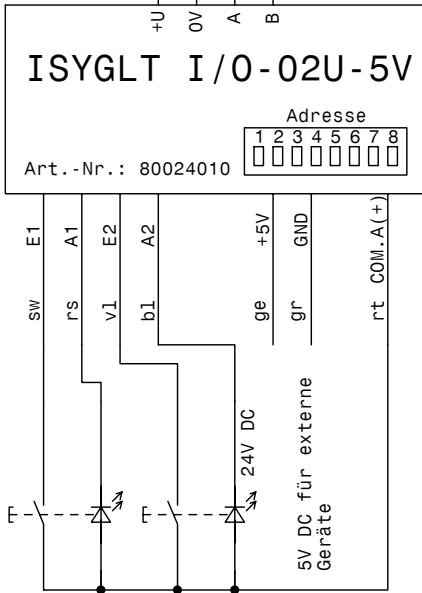
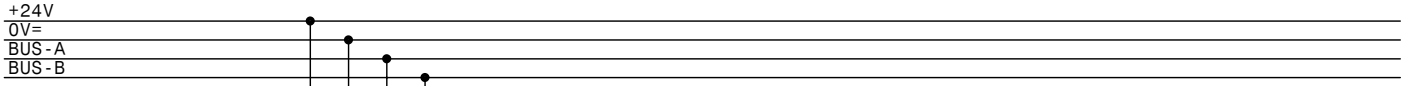

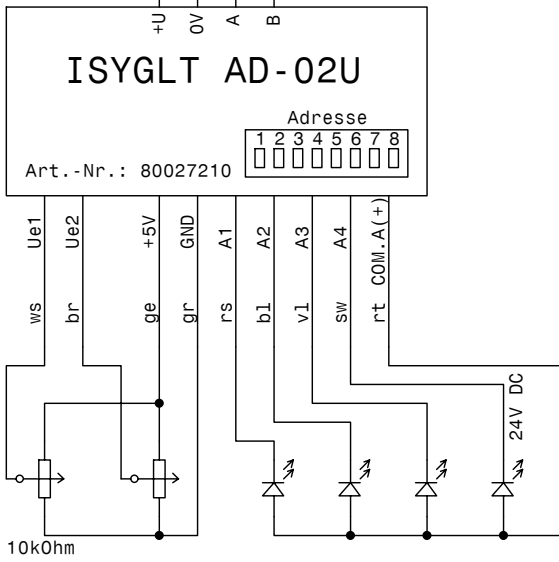
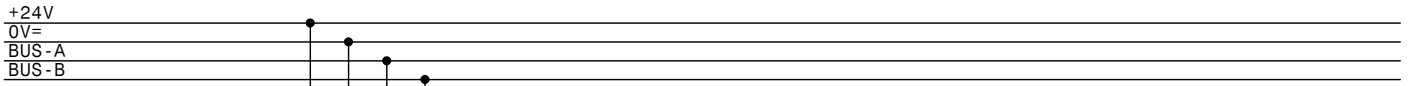

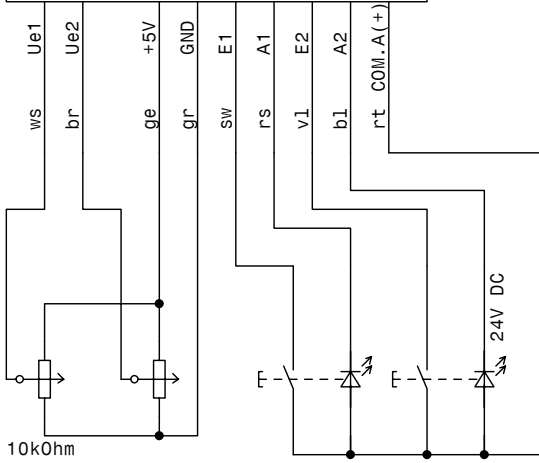
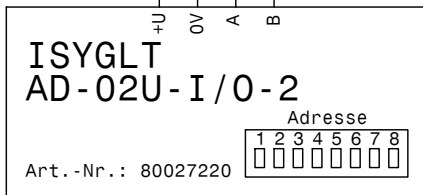
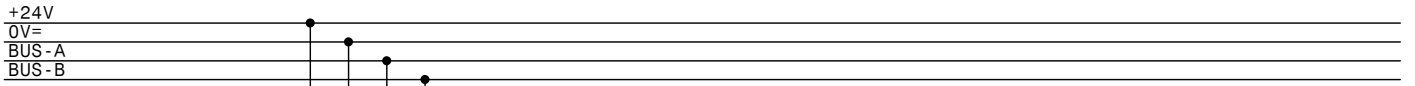

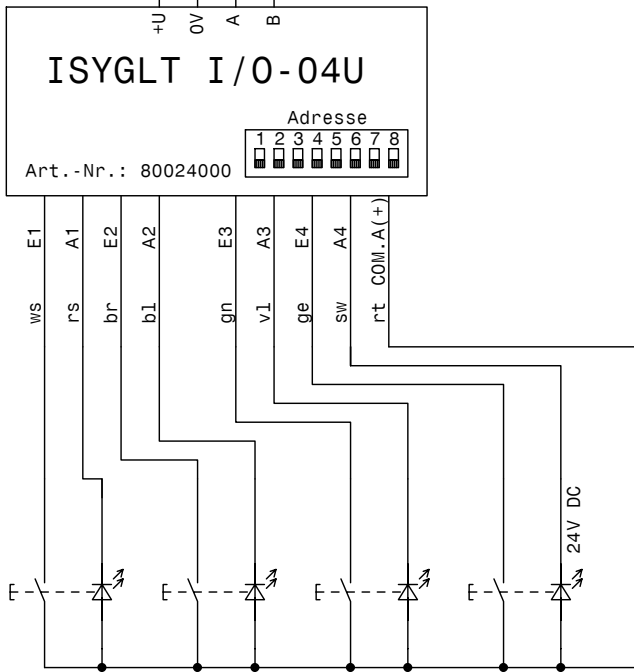
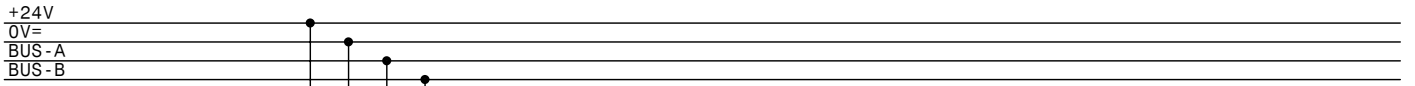

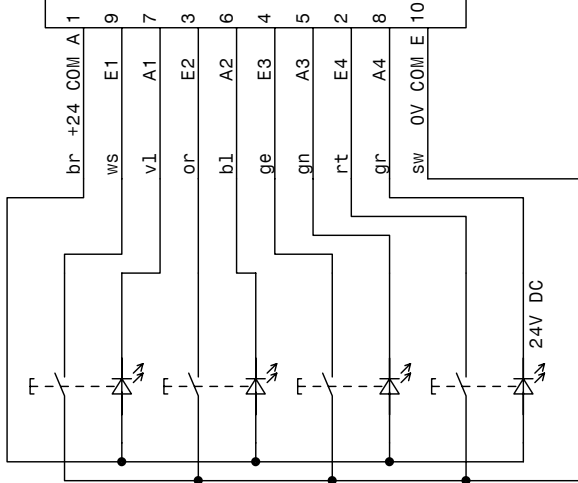
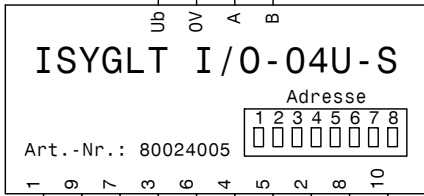
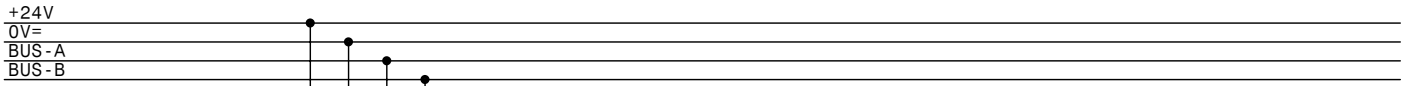

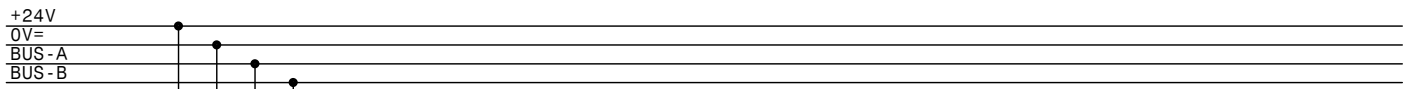

Ub
0V
BUS A
BUS B

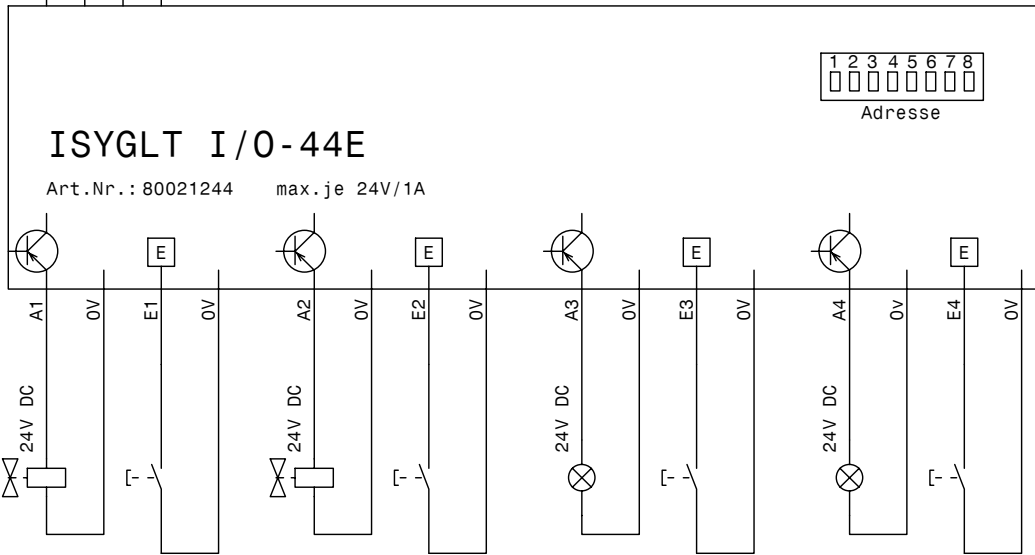

+24V
0V=
BUS-A
BUS-B

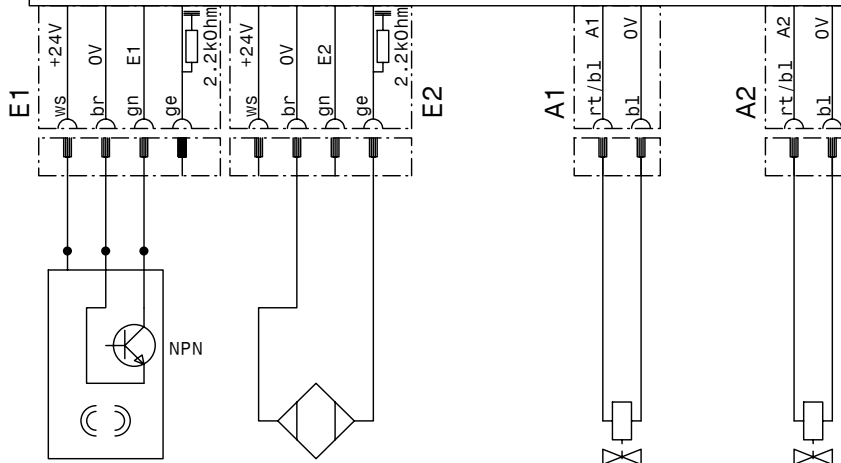
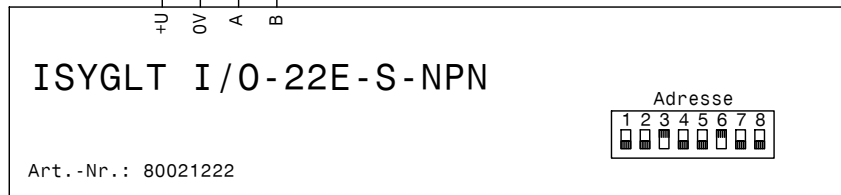

Reflexlichttaster
Streichelfliese
Piezo-Taster

Türkont.
ifm-electronics
NG5001

Warmwasser Kaltwasser
Magnetventile

+24V
 0V=
 BUS-A
 BUS-B

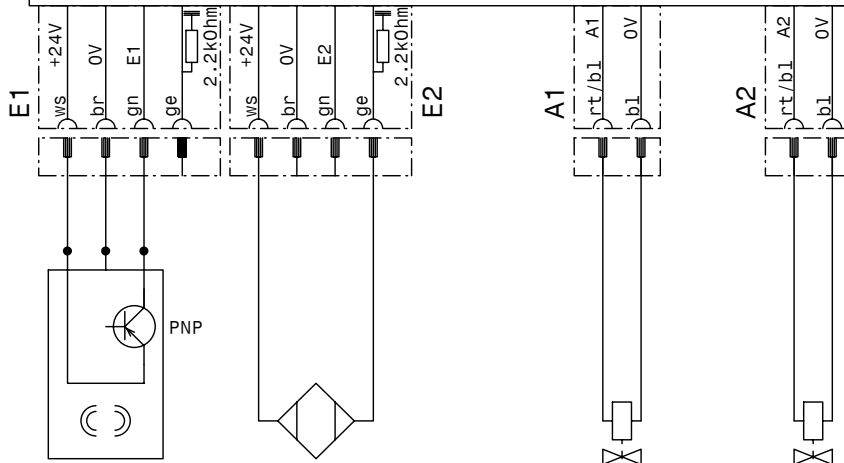
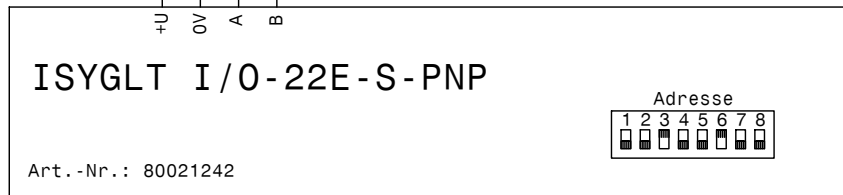

Reflexlichttaster
 Streichelfliese
 Piezo-Taster

Türkont.
 ifm-electronics
 NG5001

Warmwasser Kaltwasser
 Magnetventile

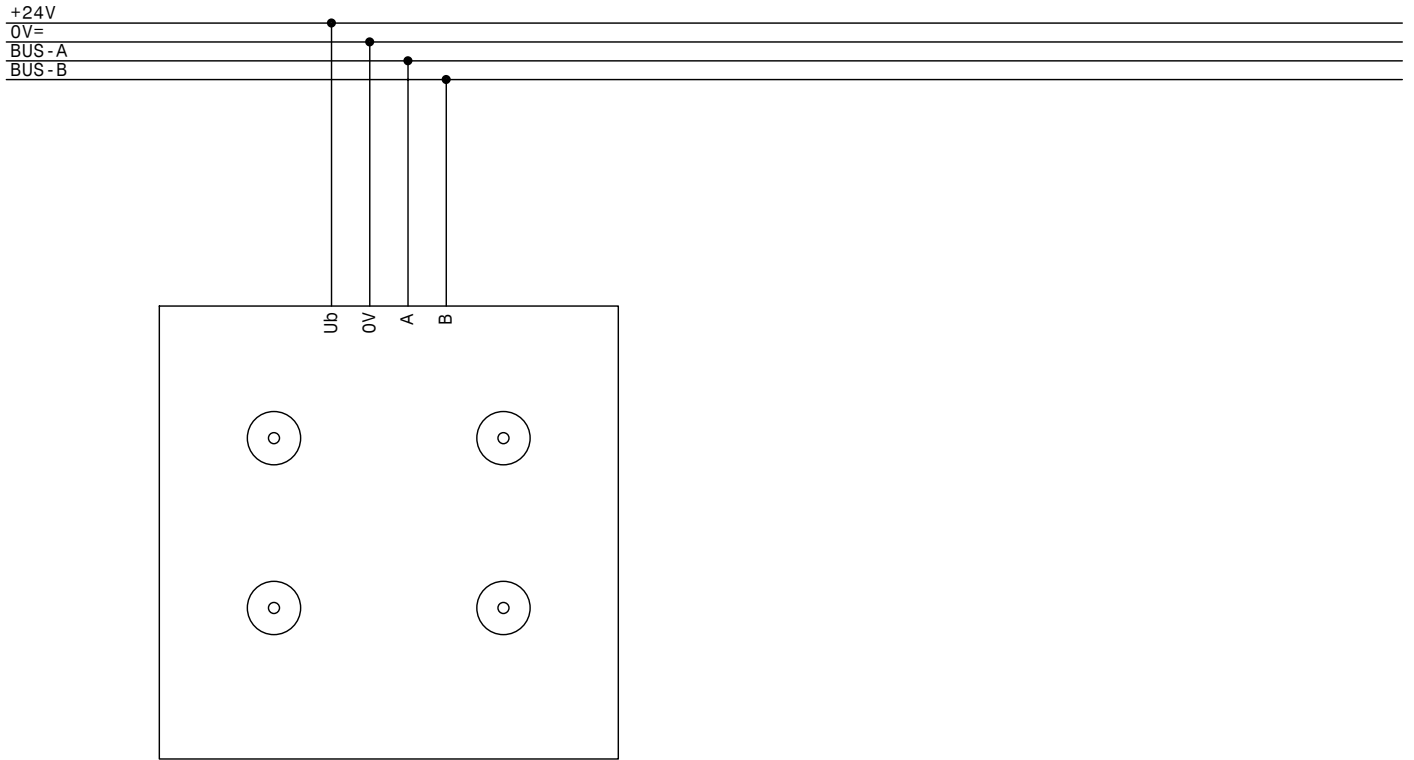

ISYGLT UPT-1SD-4T
 Tableau

Art.-Nr.: 80023110

Adresse

1	2	3	4	5	6	7	8
□	□	□	□	□	□	□	□

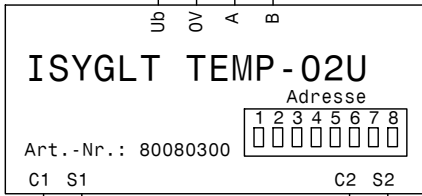
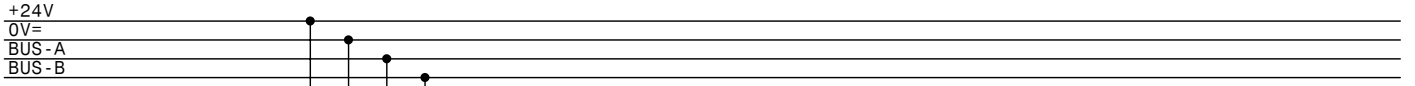

Temperaturfühler 1

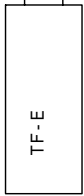

Temperaturfühler 2



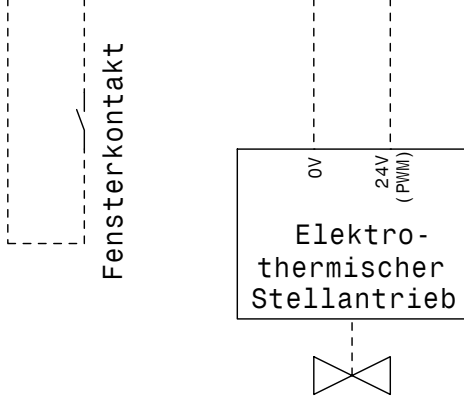
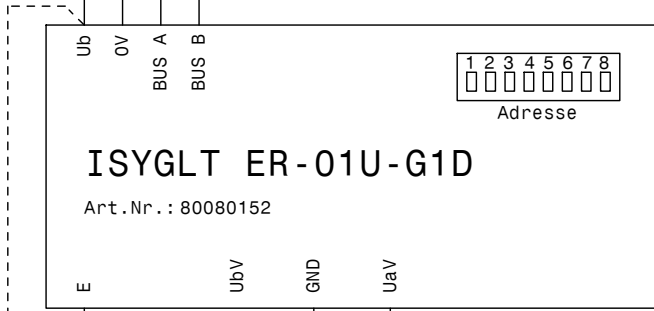
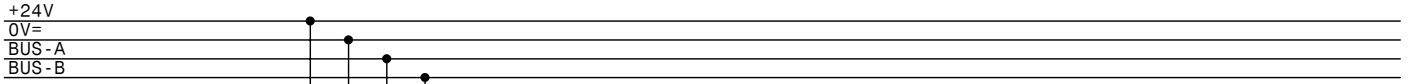

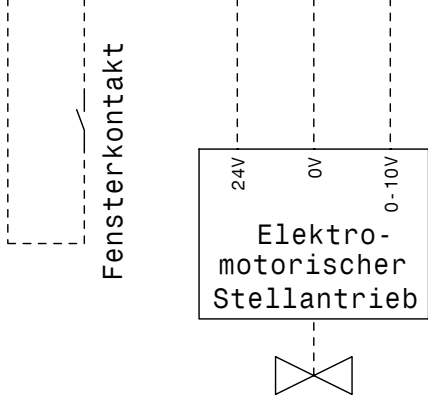
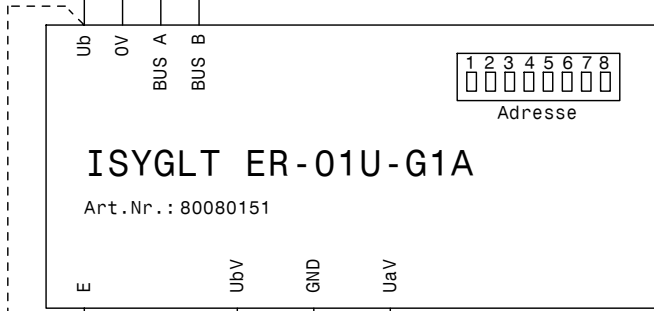
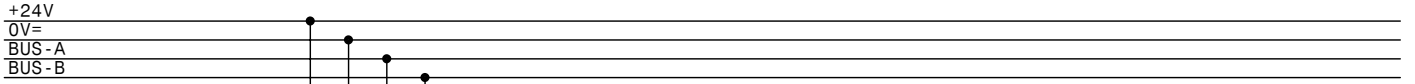

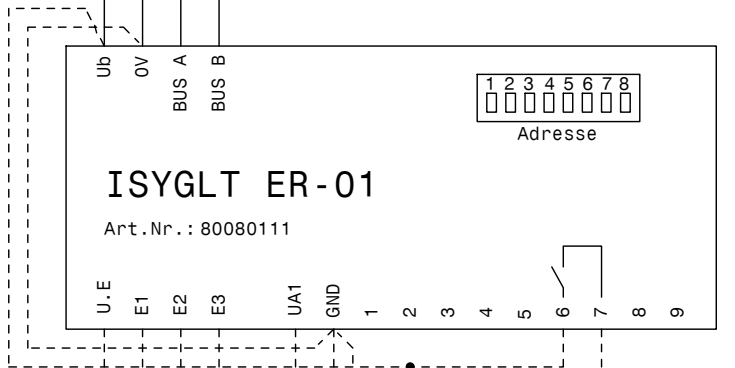
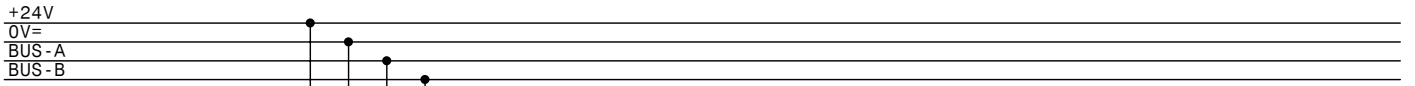

Fensterkontakt
Präsenzsensor
Taupunktsensor

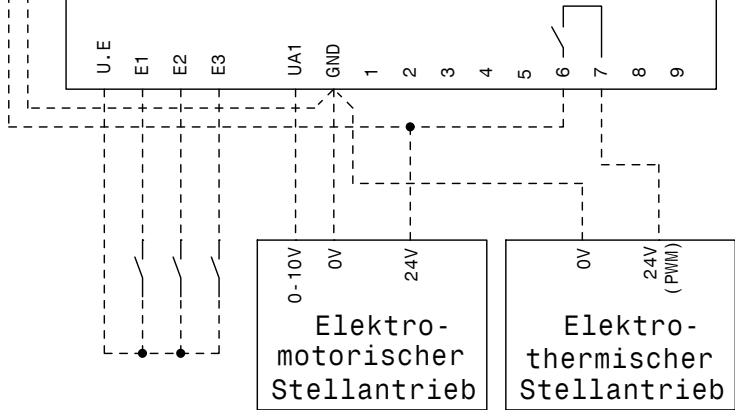
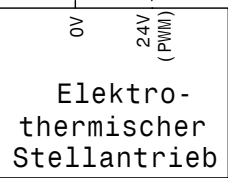
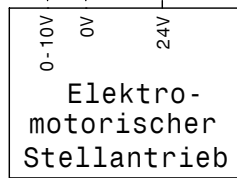

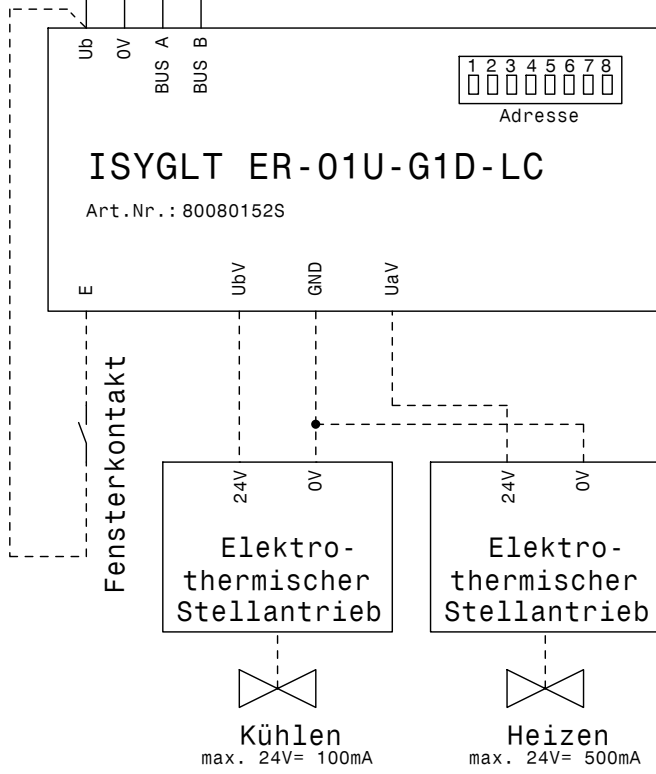
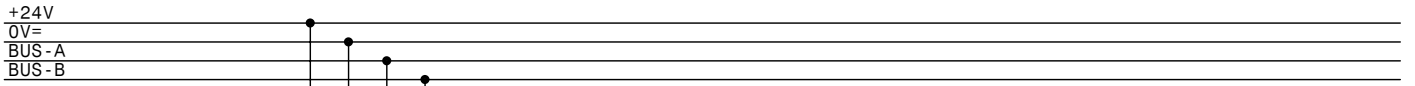

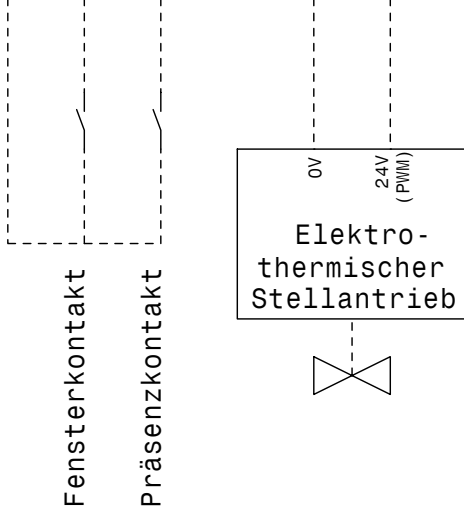
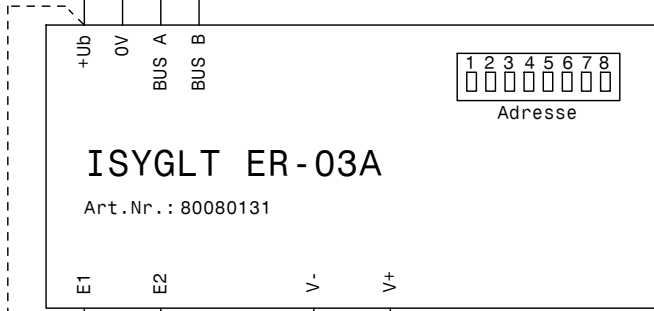
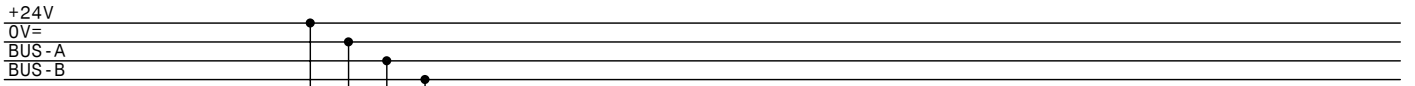

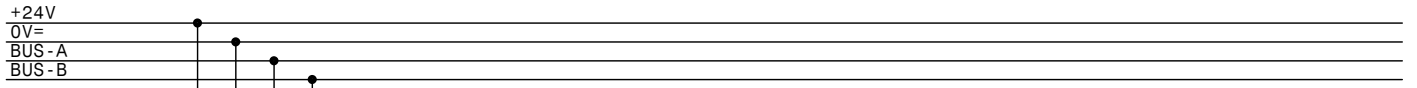

Netz 230V 50Hz

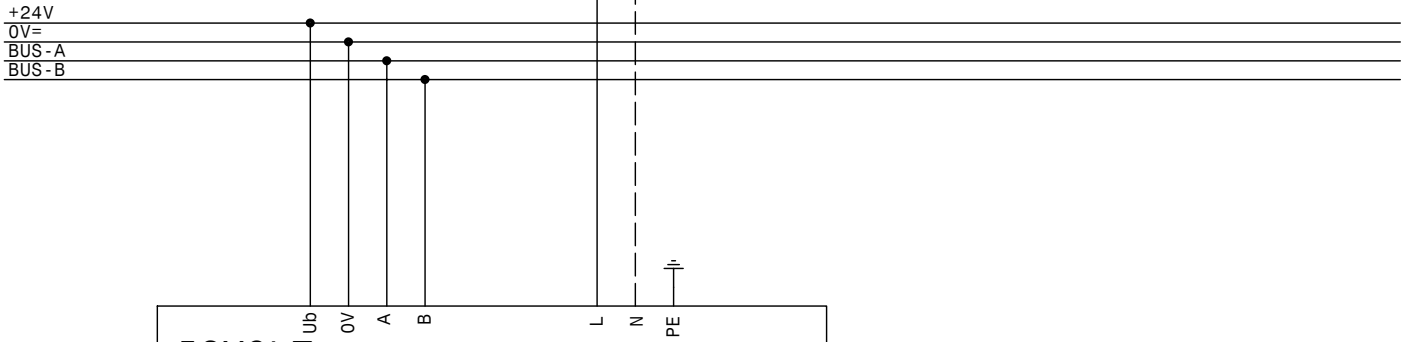

ISYGLT
Zentrale Tageslichterfassung
ZTLS-04

Art.-Nr.: 80085110

Adresse

1	2	3	4	5	6	7	8	Nord
1	2	3	4	5	6	7	8	Ost
1	2	3	4	5	6	7	8	Süd
1	2	3	4	5	6	7	8	West

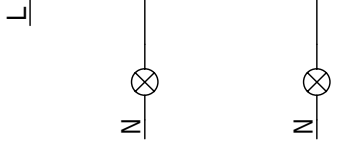
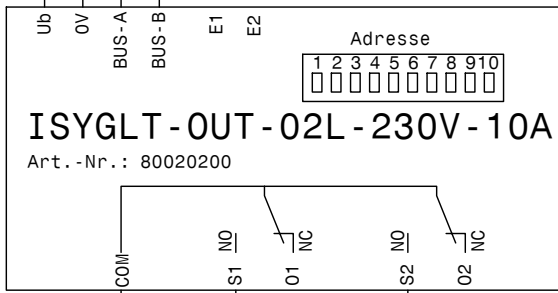
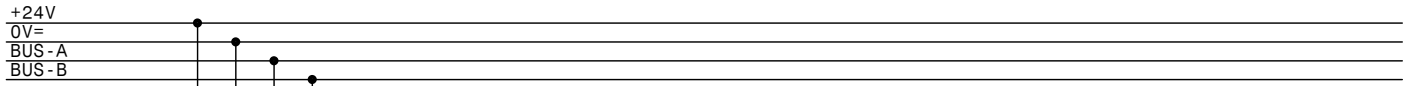

Anschluß wahlweise als Öffner oder Schliesser möglich

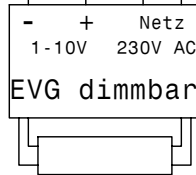
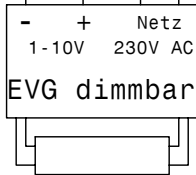
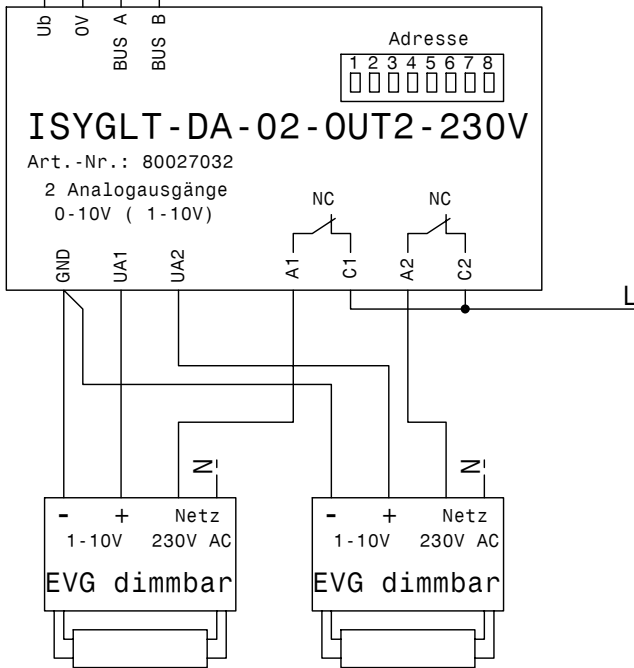
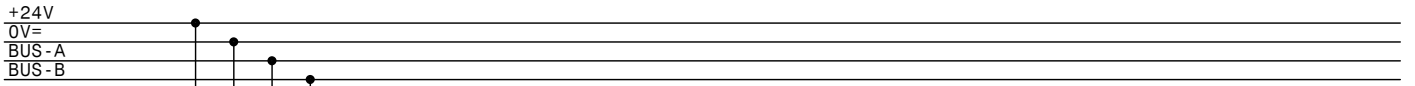

Leuchteneinbaugerät

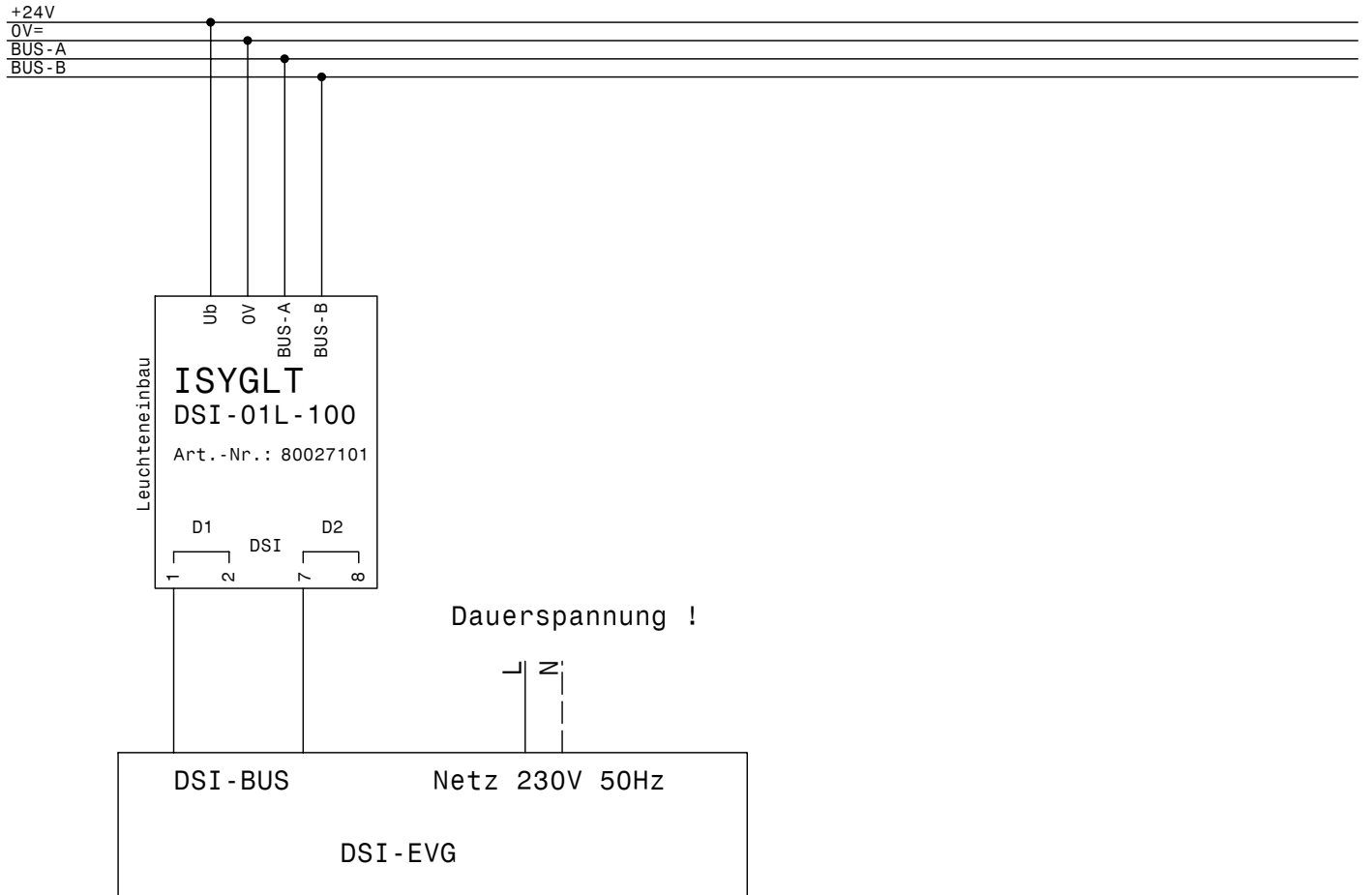

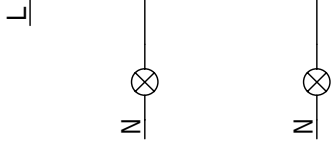
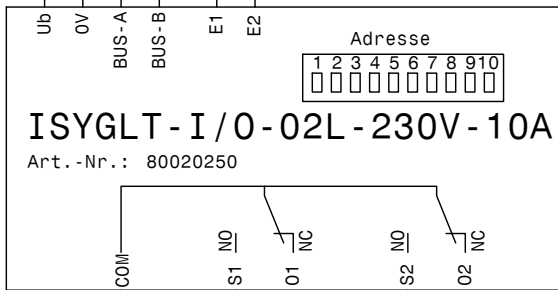
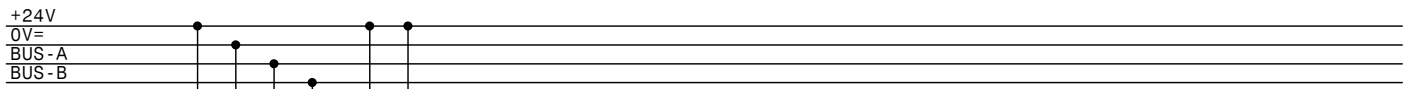

Anschluß wahlweise als Öffner
oder Schliesser möglich

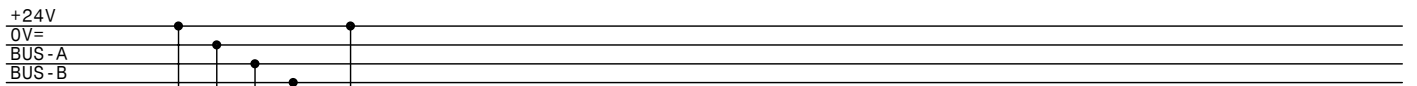

ext. Rückmeldekontakt

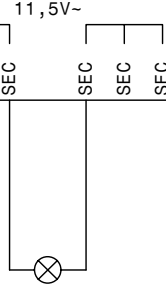
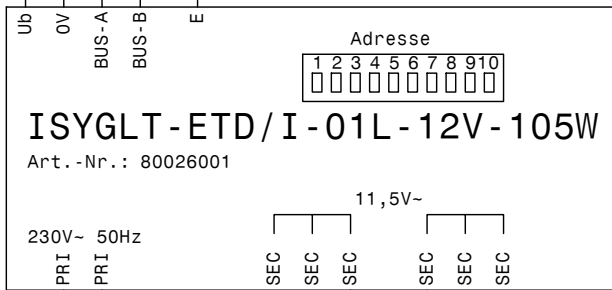

NV-Halogenlampe 12V max. 105W

Netz 230V 50Hz

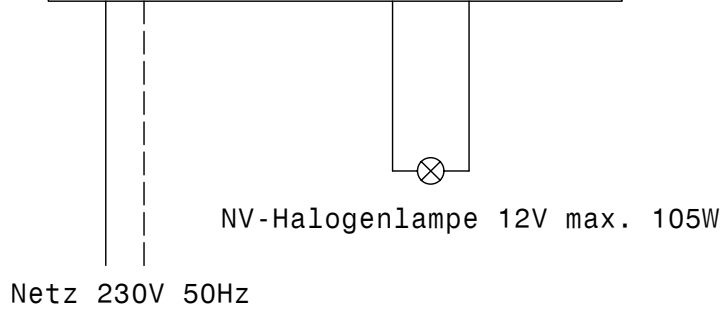
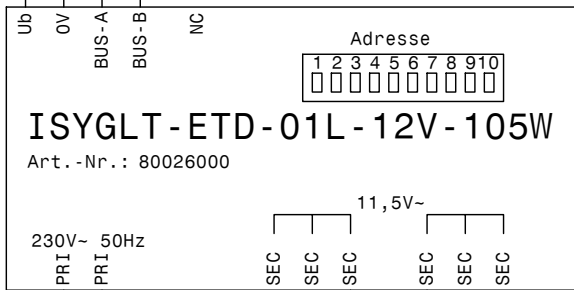
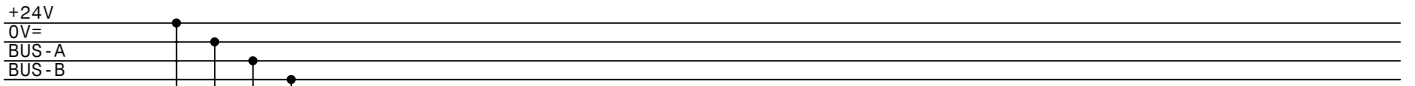

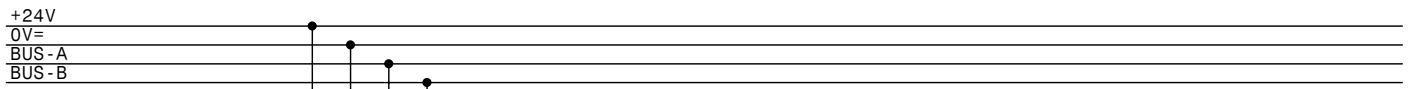

U	OV	A	B				
ISYGLT							
IR-Empfänger							
IRE-U-LC							
Adresse							
1	2	3	4	5	6	7	8
□	□	□	□	□	□	□	□
Art.-Nr.: 80040155							

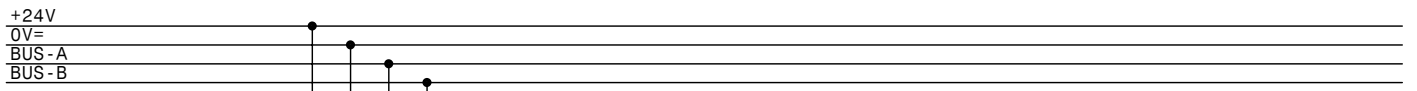

U OV A B

ISYGLT Funkuhr
DCF-77

Art.-Nr.: 80070100

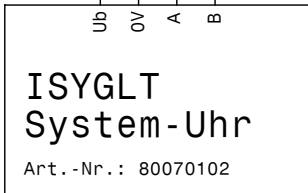
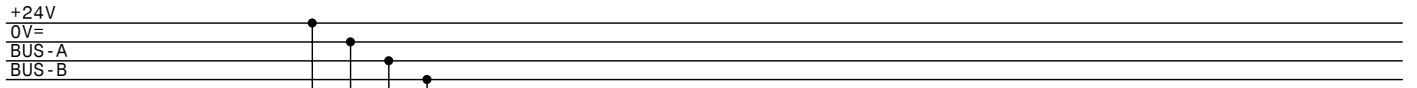

+24V
0V=
BUS-A
BUS-B

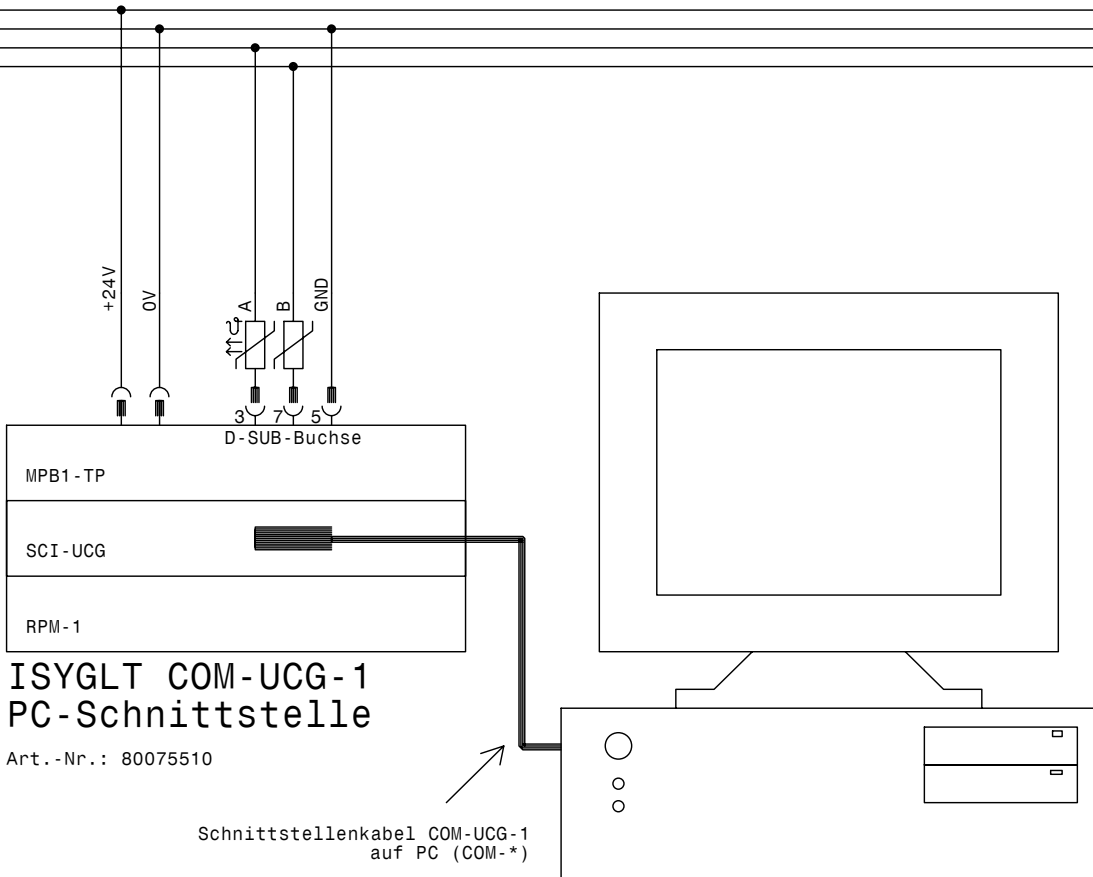

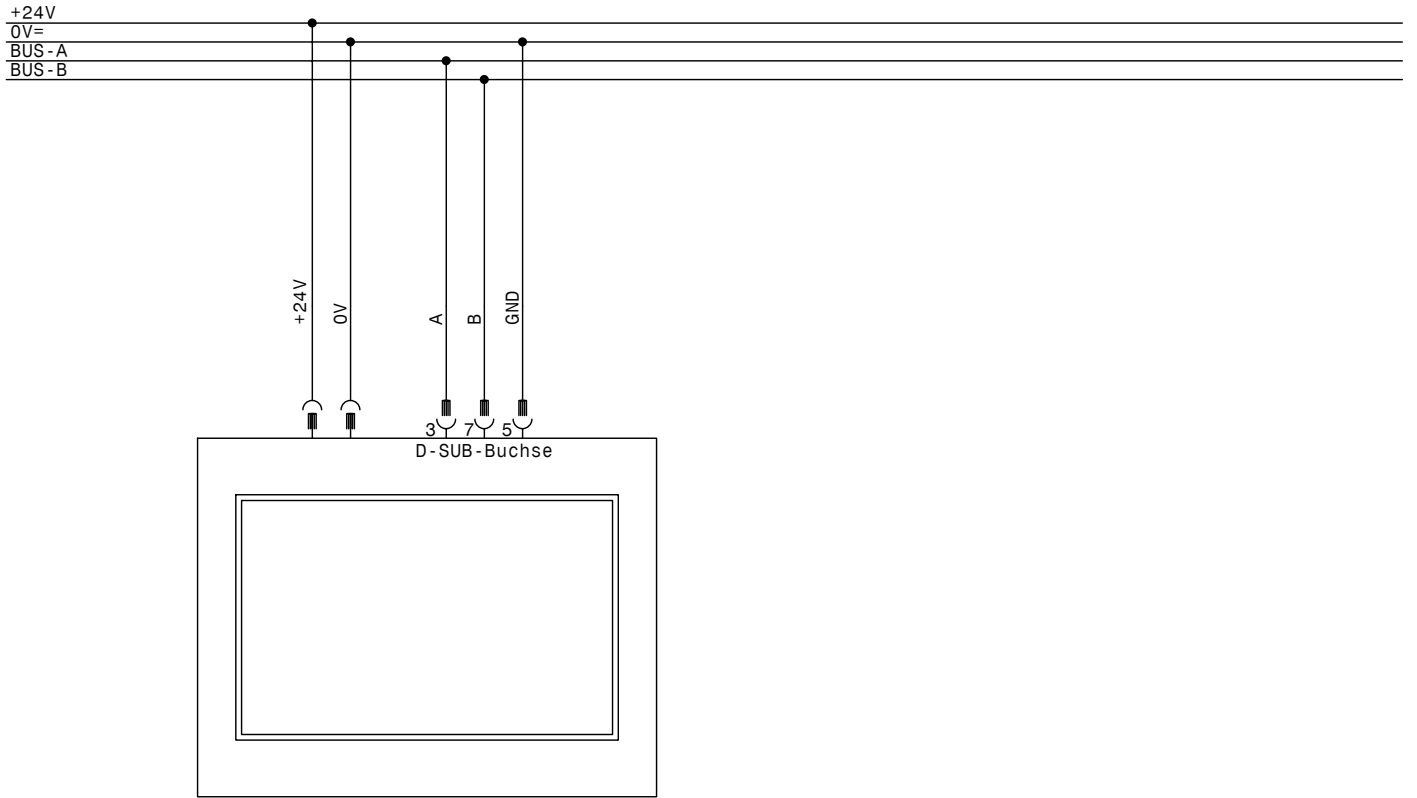

ISYGLT Touch-Panel1

Art.-Nr.: 80075***

L-St. (230V/50Hz)

N-St.

+24V

0V=

BUS-A

BUS-B

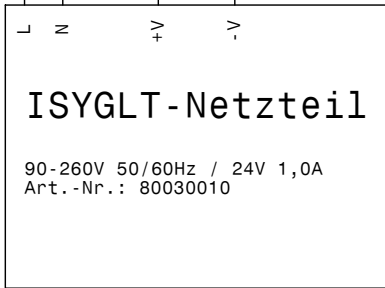

L-St. (230V/50Hz)

N-St.

+24V

0V=

BUS-A

BUS-B

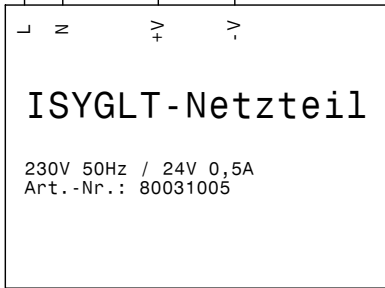

L-St. (230V/50Hz)

N-St.

+24V

0V=

BUS-A

BUS-B

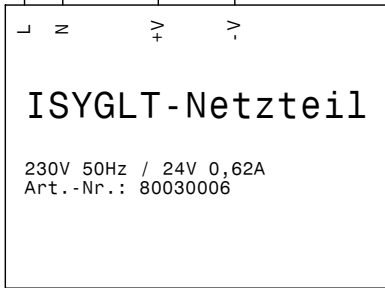

ISYGLT-Netzteil

230V 50Hz / 24V 0,62A
Art.-Nr.: 80030006

L-St. (230V/50Hz)

N-St.

+24V

0V=

BUS-A

BUS-B

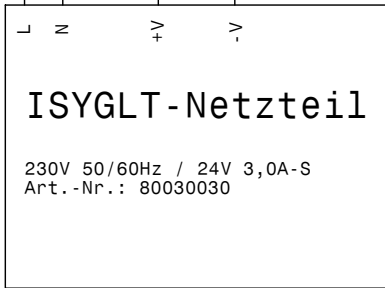

ISYGLT-Netzteil

230V 50/60Hz / 24V 3,0A-S
Art.-Nr.: 80030030

L-St. (230V/50Hz)

N-St.

+24V

0V=

BUS-A

BUS-B

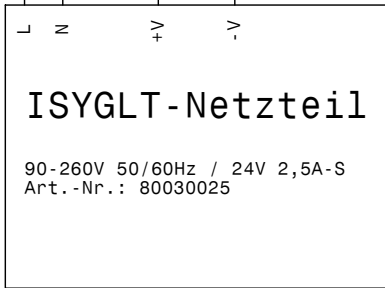

ISYGLT-Netzteil

90-260V 50/60Hz / 24V 2,5A-S
Art.-Nr.: 80030025

L-St. (230V/50Hz)

N-St.

+24V

0V=

BUS-A

BUS-B

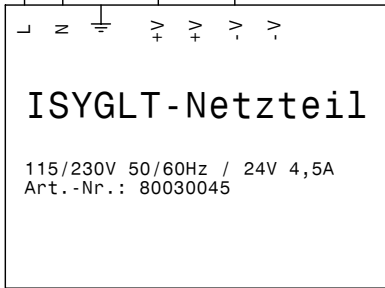

L-St. (230V/50Hz)

N-St.

+24V

0V=

BUS-A

BUS-B

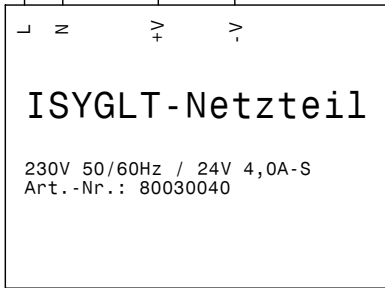

ISYGLT-Netzteil

230V 50/60Hz / 24V 4,0A-S
Art.-Nr.: 80030040

L-St. (230V/50Hz)

N-St.

+24V

0V=

BUS-A

BUS-B

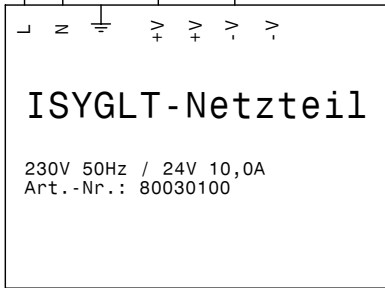

ISYGLT-Netzteil

230V 50Hz / 24V 10,0A
Art.-Nr.: 80030100

L-St. (230V/50Hz)

N-St.

+24V

0V=

BUS-A

BUS-B

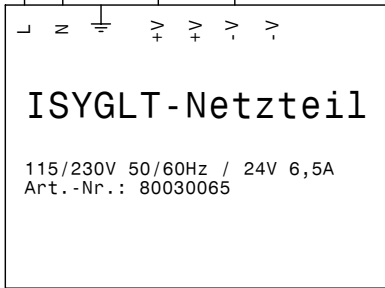

ISYGLT-Netzteil

115/230V 50/60Hz / 24V 6,5A
Art.-Nr.: 80030065

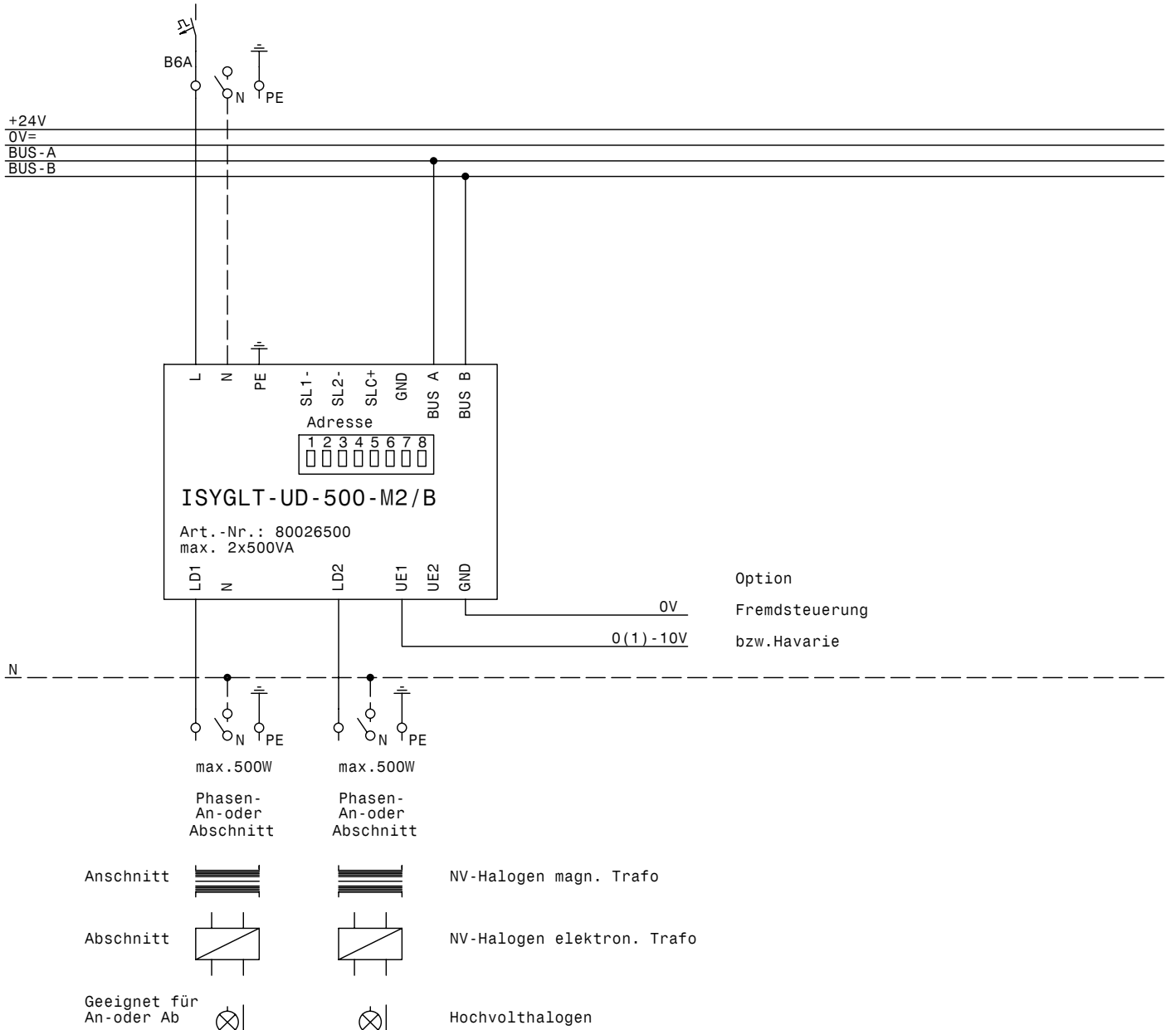

Wir empfehlen
 Abschnittdimmung :
 -Schonung des Leuchtmittels
 -Längere Lebensdauer

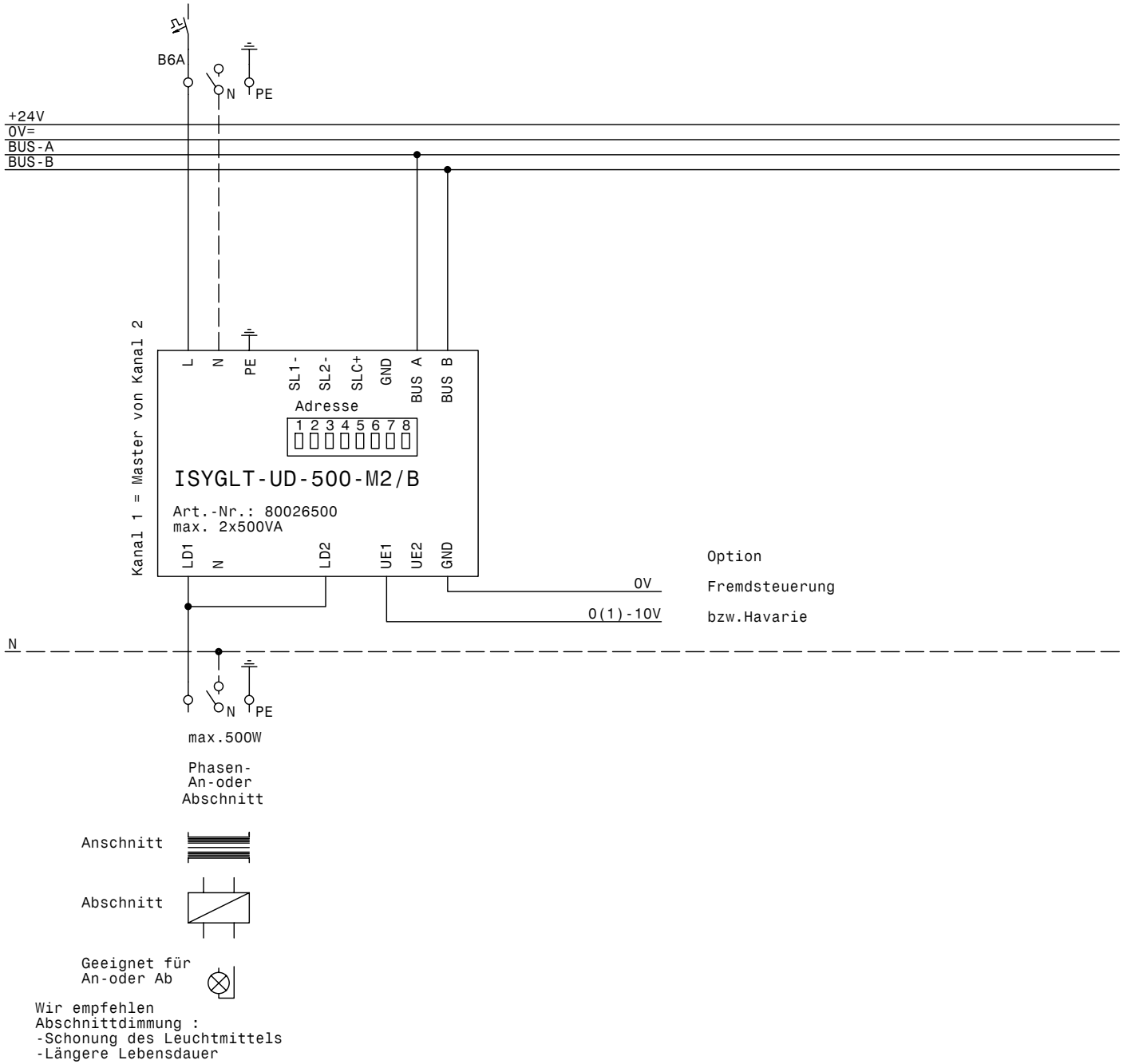

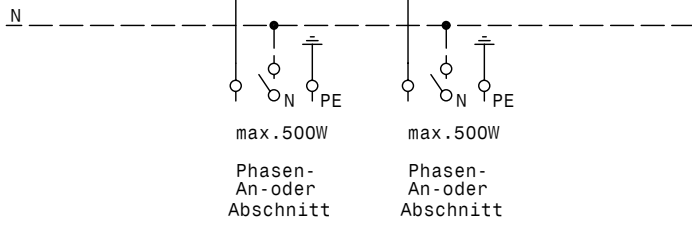
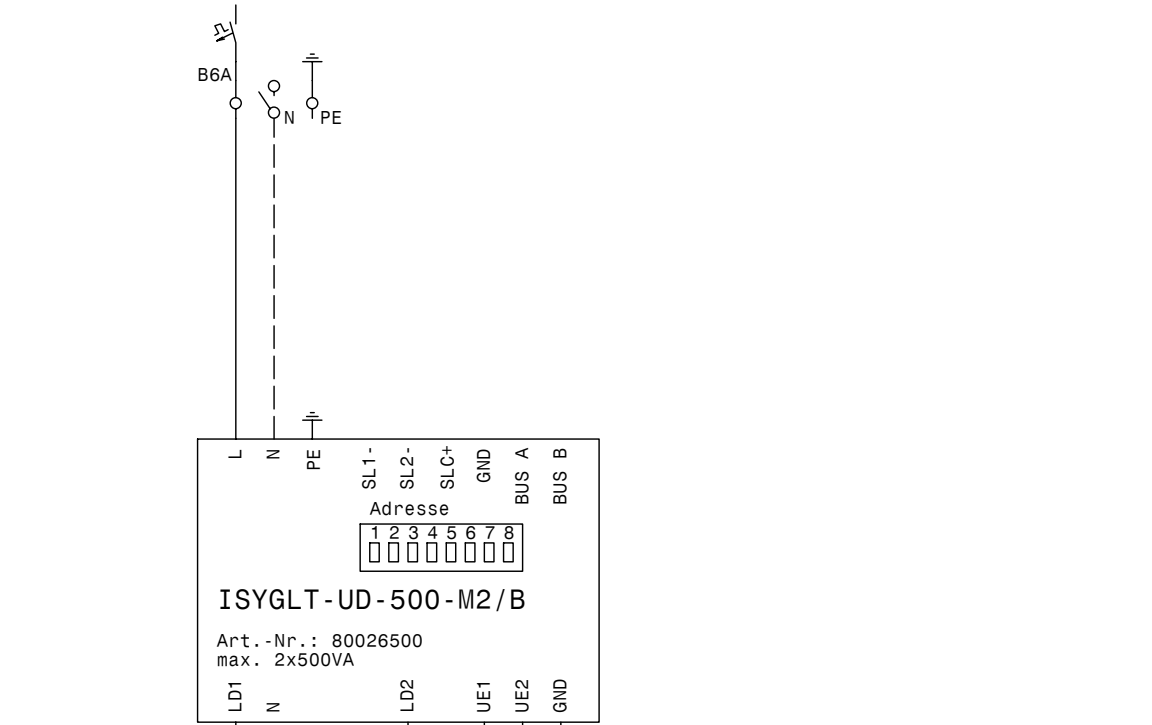

- | | | |
|-------------------------|--|----------------------------|
| Anschnitt | | NV-Halogen magn. Trafo |
| Abschnitt | | NV-Halogen elektron. Trafo |
| Geeignet für An-oder Ab | | Hochvolthalogen |

Wir empfehlen
 Abschnittdimmung :
 -Schonung des Leuchtmittels
 -Längere Lebensdauer

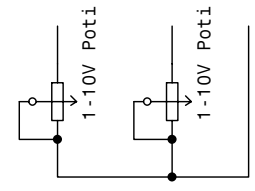

Option 1-10V Poti

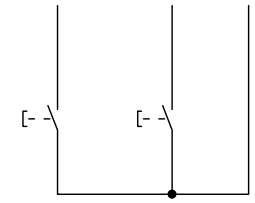

Option 1-Tastendimmer

Netzteile redundant betrieben mit NT-2/1

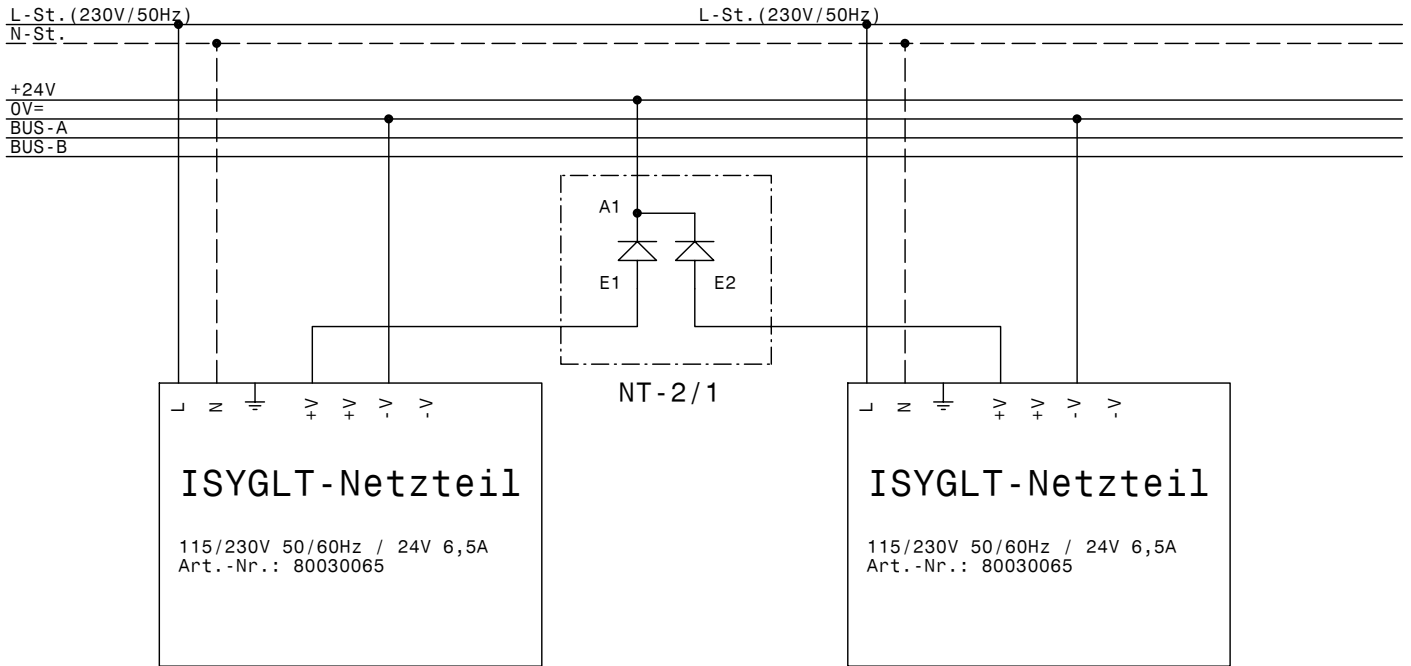

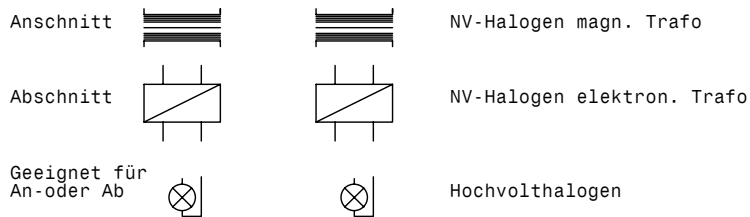
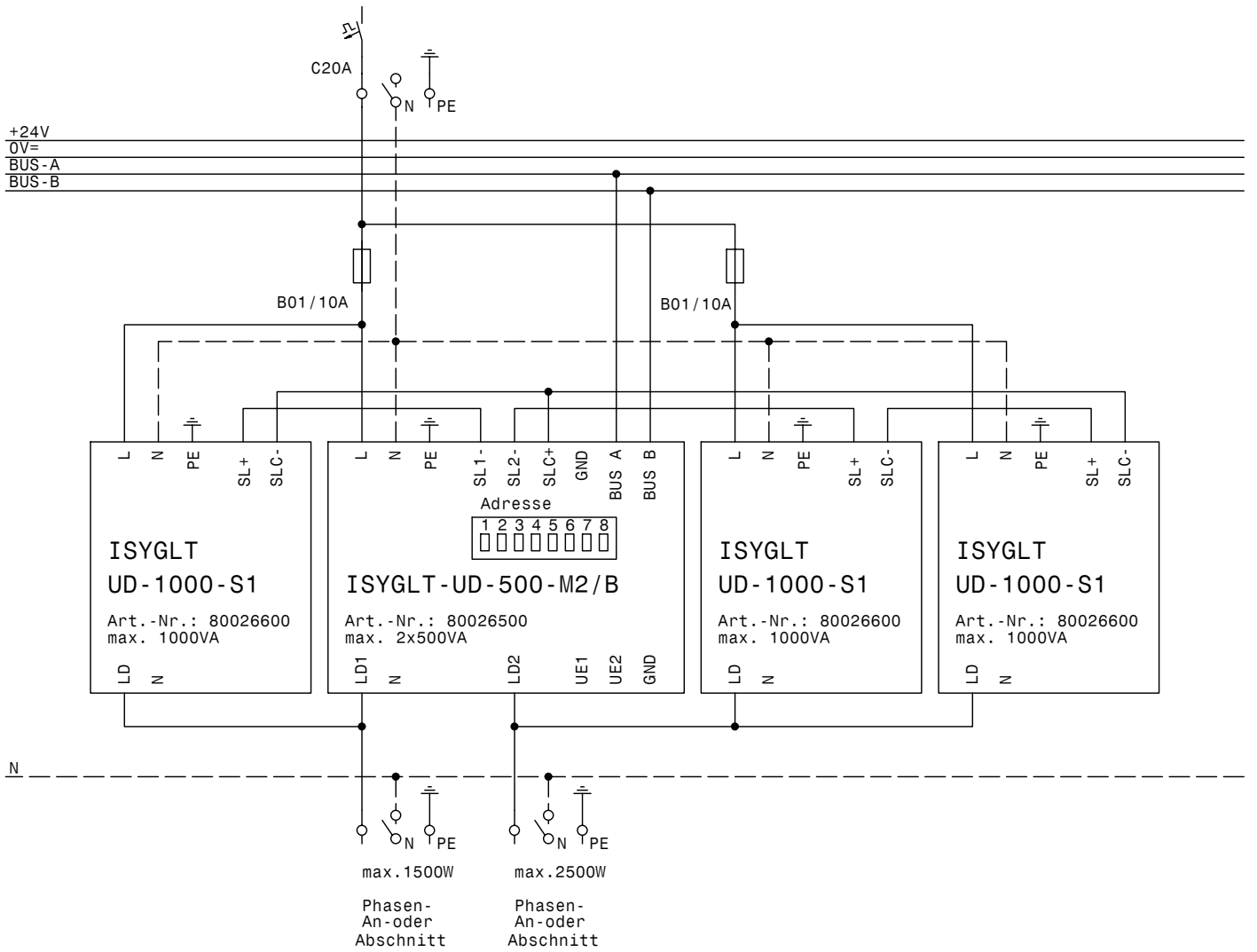

Wir empfehlen
 Abschnittdimmung :
 -Schonung des Leuchtmittels
 -Längere Lebensdauer

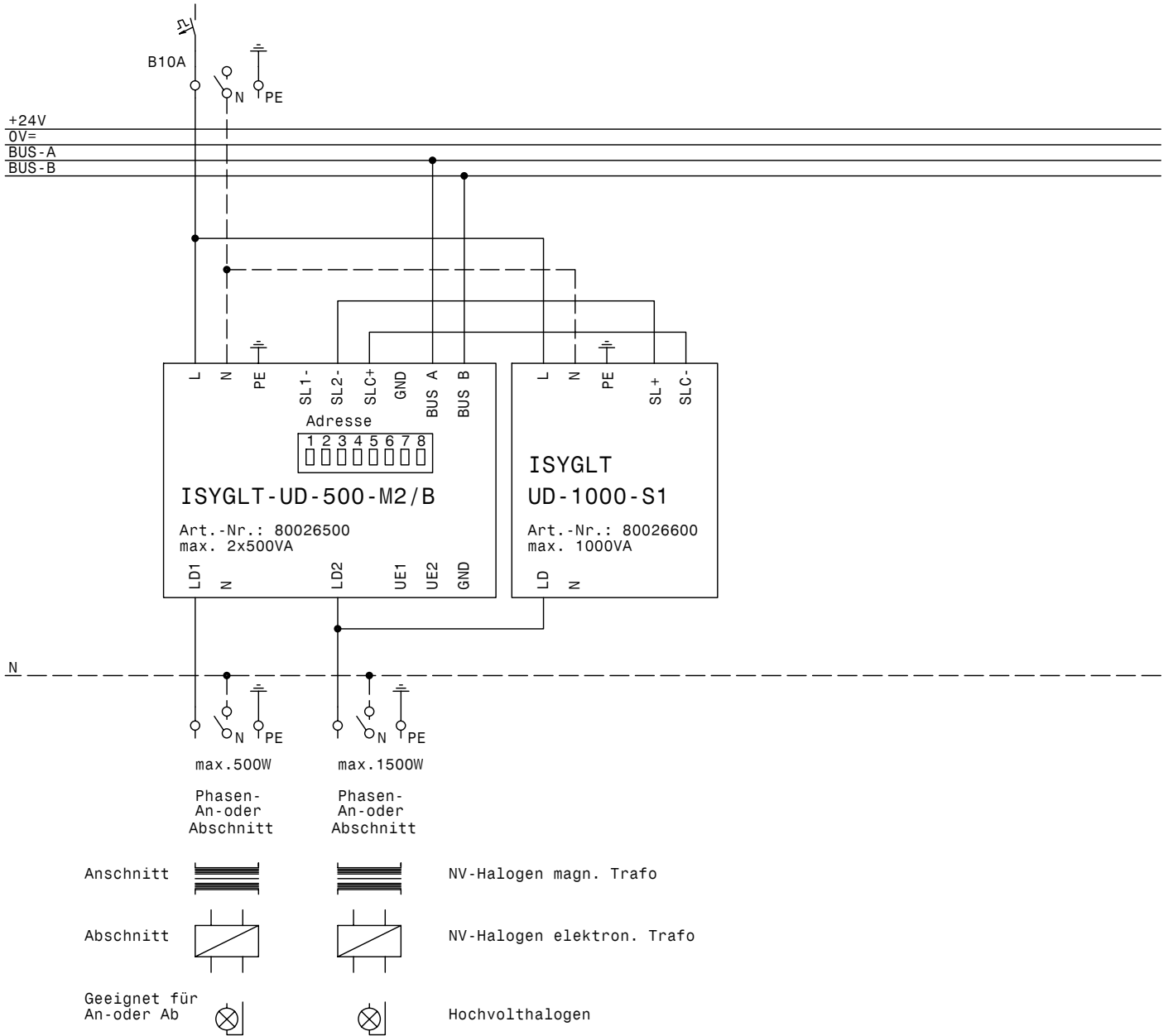

Wir empfehlen
 Abschnittdimmung :
 -Schonung des Leuchtmittels
 -Längere Lebensdauer

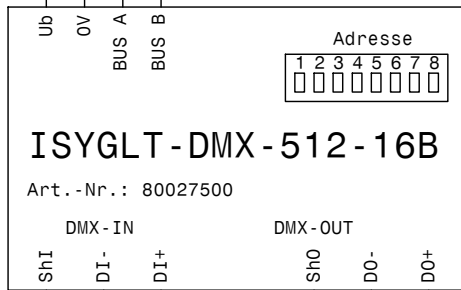
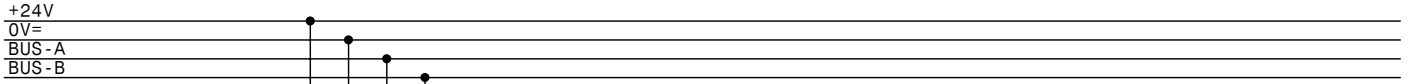

XLR-5-pol.

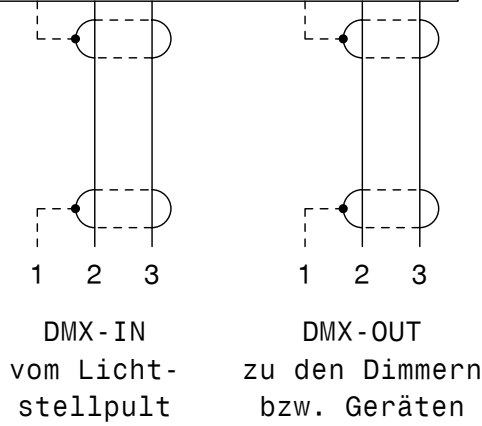

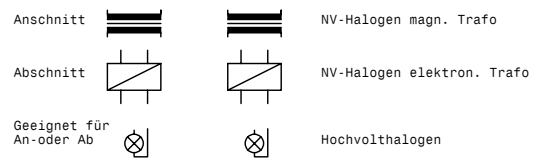
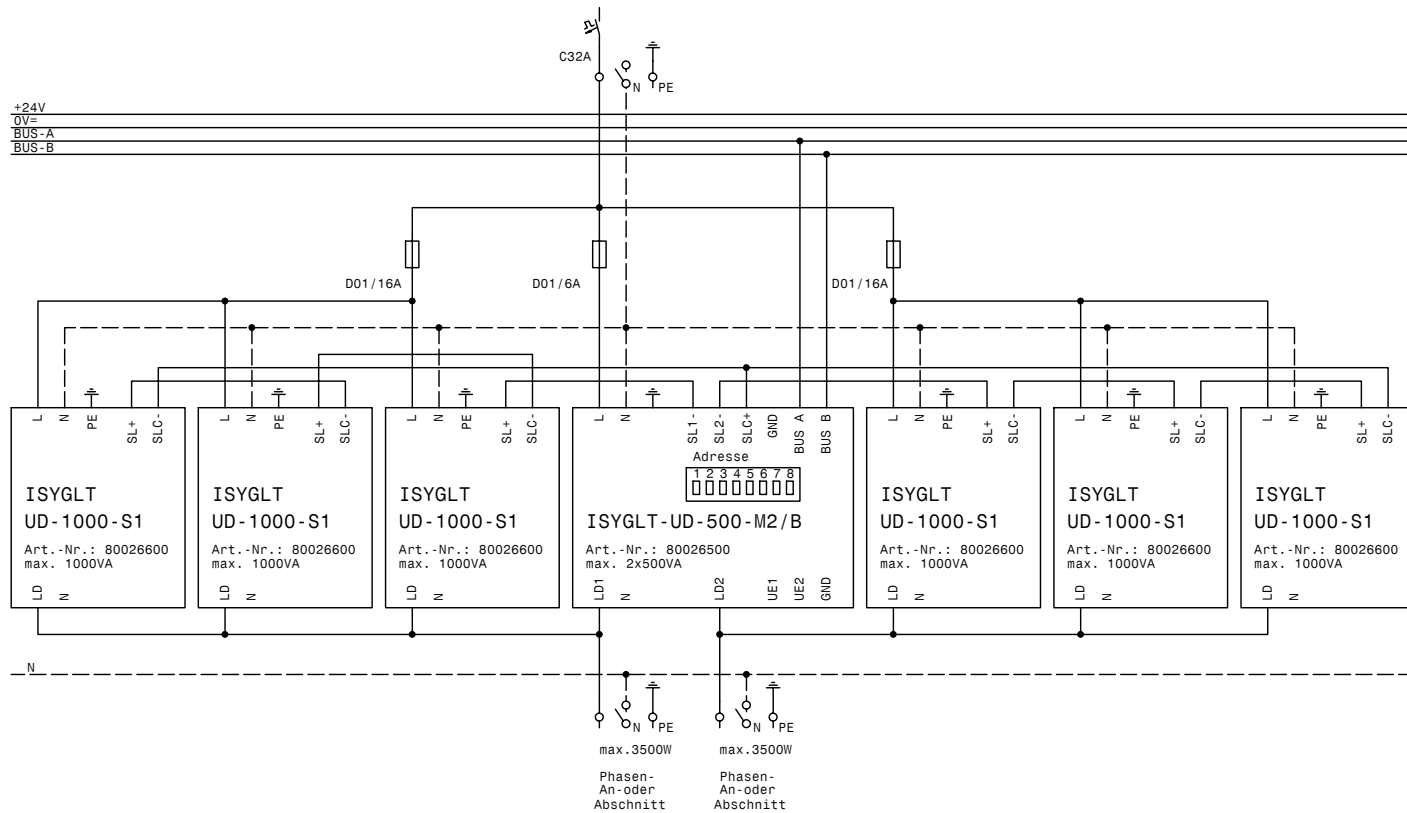

Wir empfehlen
 Abschnittdimmung :
 -Schonung des Leuchtmittels
 -Längere Lebensdauer

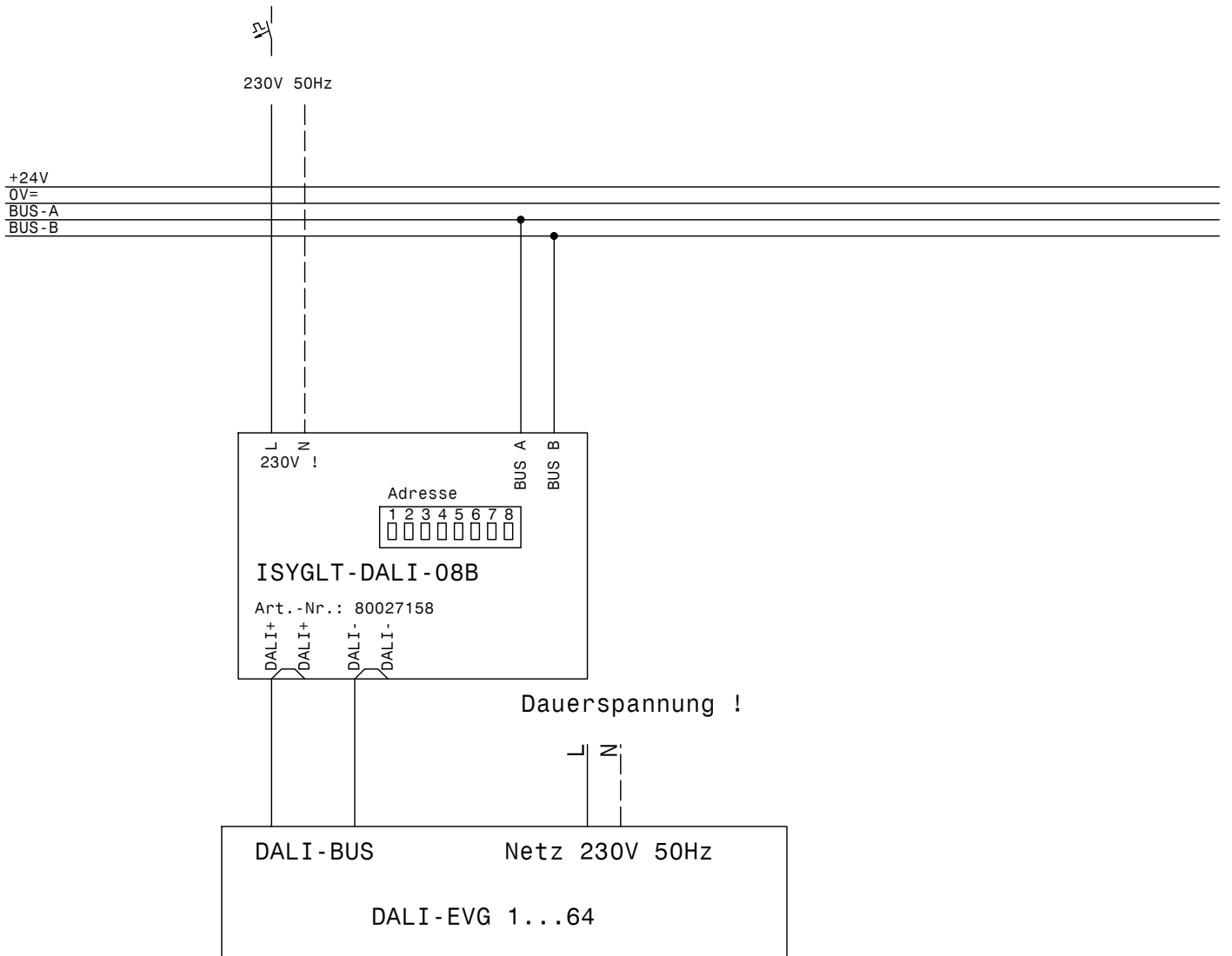

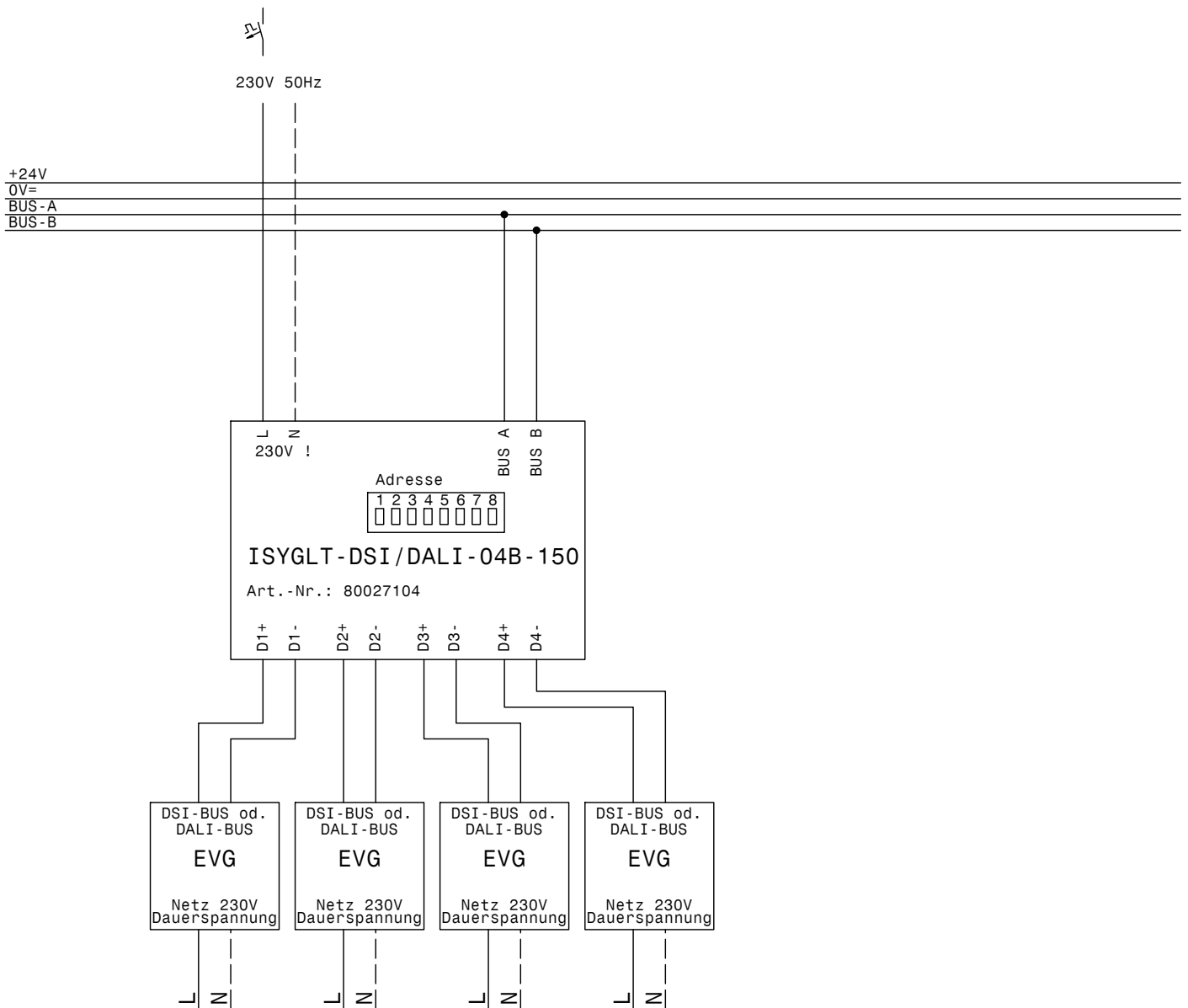

Dauerspannung !

Max. 50 EVG/Ausgang Max. 150 EVG gesamt !
Achtung! Die Betriebsart DALI oder DSI muss am
Modul für alle Abgänge vorgewählt werden!

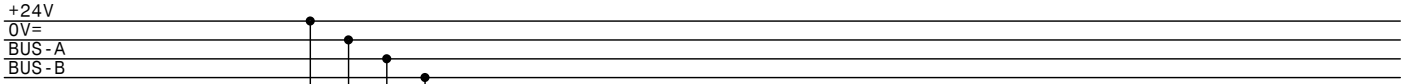

ISYGLT
 Tableau-Koppler
 TS-M1

Adresse
 1 2 3 4 5 6 7 8
 □ □ □ □ □ □ □ □

Art.-Nr.: 80023200

Freigabe nur für
Merten Aufsätze !!!

System M
 1-fach Art.Nr.:(6233xx)
 2-fach Art.Nr.:(6234xx)
 4-fach Art.Nr.:(6238xx)

OctoColor
 1-fach Art.Nr.:(6204xx)
 2-fach Art.Nr.:(6205xx)
 4-fach Art.Nr.:(6206xx)

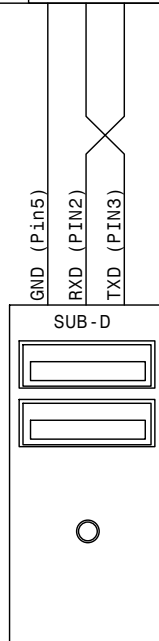
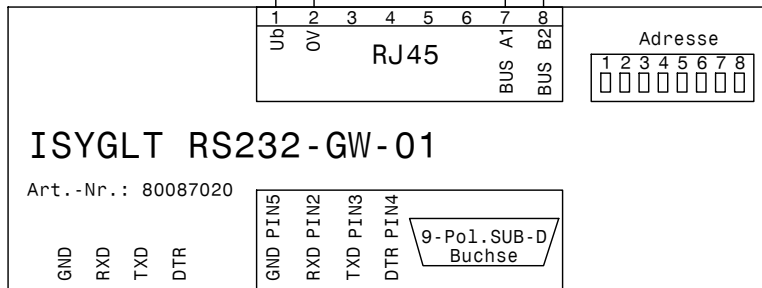
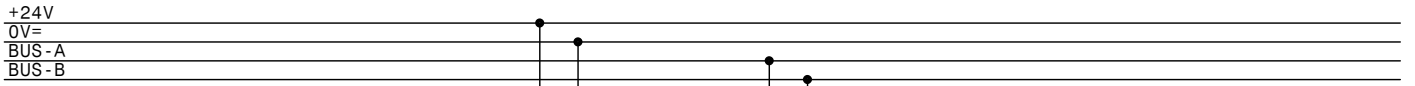

Ext. Gerät / PC

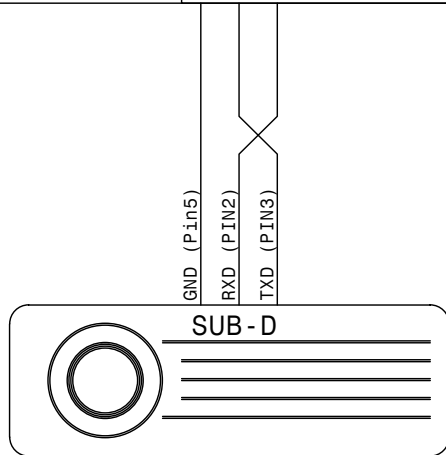
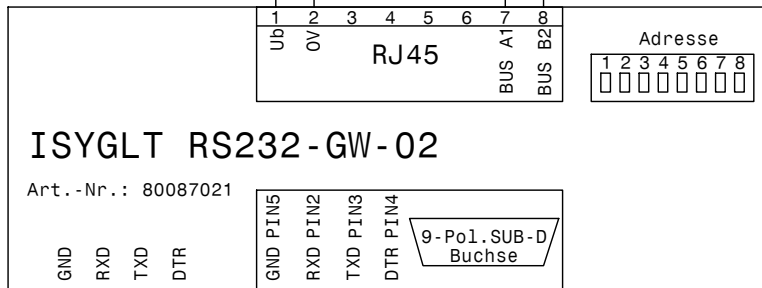
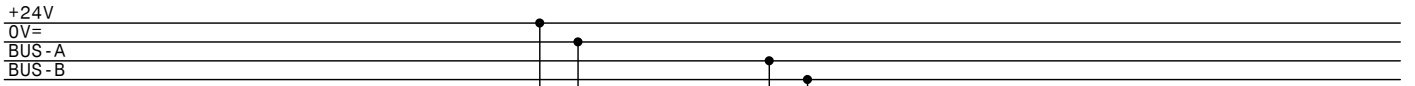

Ext. Gerät / z.B. Beamer

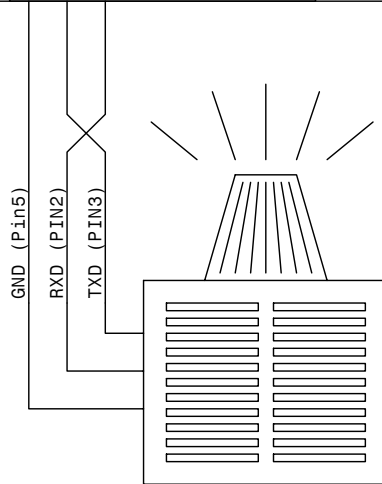
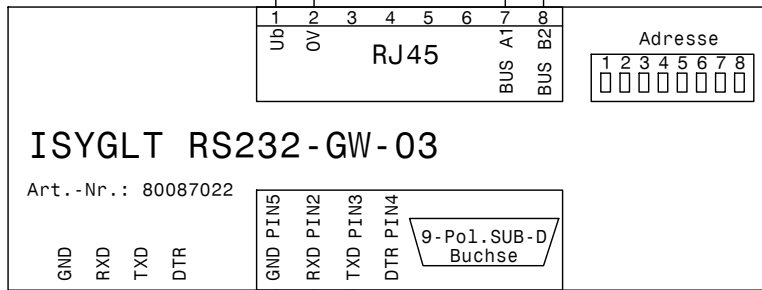
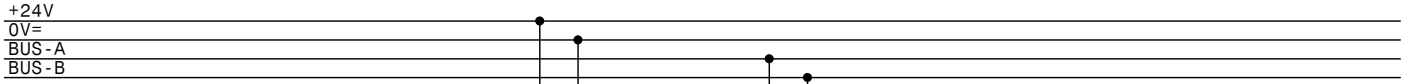

Sonderprotokoll
 Einbruchmeldezentrale

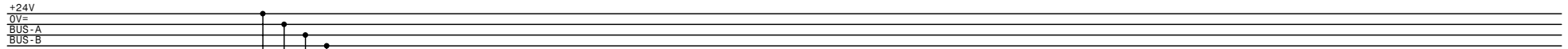



A
B

Ub
0V
BUS A
BUS B

-A
ISYGLT LED-08T

Adresse

1	2	3	4	5	6	7	8

Art.Nr.: 80027040

	X2 LED Balken		1	2	3	4	5	6	7	8	9	10	11	12	13	14	15	16				
	X3 LED Dioden		1	2	3	4	5	6	7	8	9	10	11	12	13	14	15	16	17	18	19	20

Achtung!!!
nur
X2 oder X3
verwenden

GND	Ua1+	LED1-	LED1+	GND	Ua2+	LED2-	LED2+	GND	Ua3+	LED3-	LED3+	GND	Ua4+	LED4-	LED4+	GND	Ua5+	LED5-	LED5+	GND	Ua6+	LED6-	LED6+	GND	Ua7+	LED7-	LED7+	GND	Ua8+	LED8-	LED8+	GND	GND	GND	GND
-----	------	-------	-------	-----	------	-------	-------	-----	------	-------	-------	-----	------	-------	-------	-----	------	-------	-------	-----	------	-------	-------	-----	------	-------	-------	-----	------	-------	-------	-----	-----	-----	-----

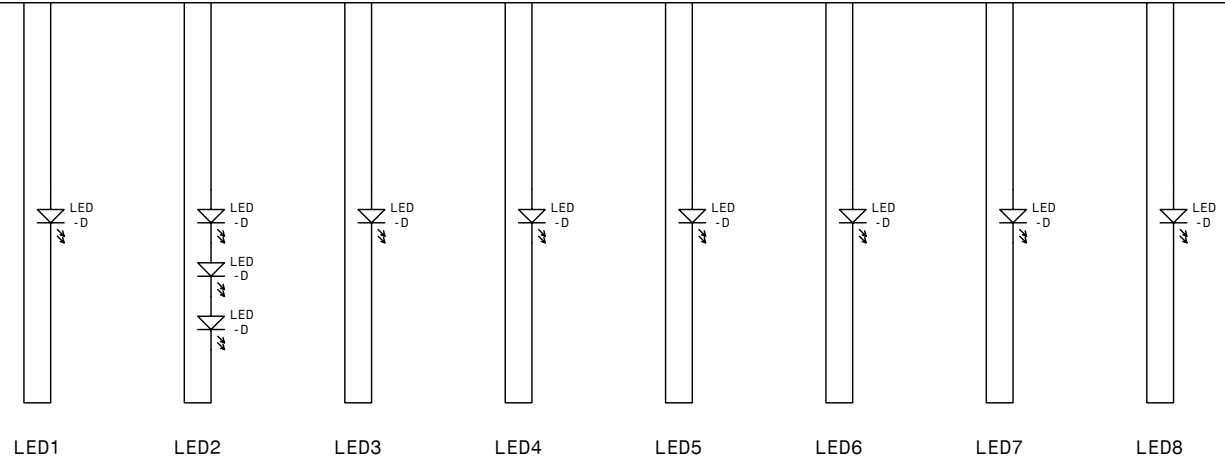

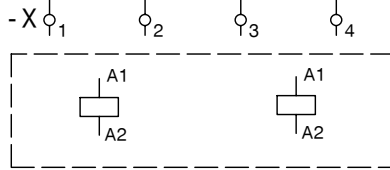
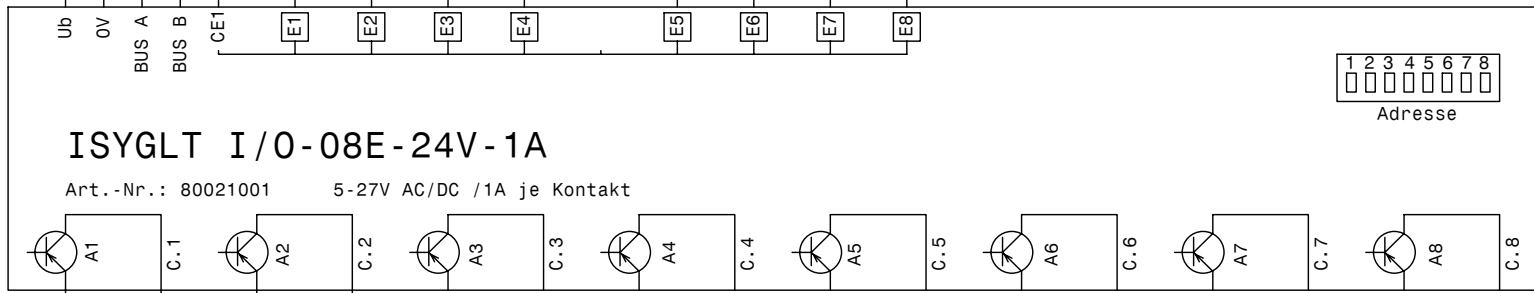

Anwendung
 Torsteuerung
 über pot. freie
 Kontakte

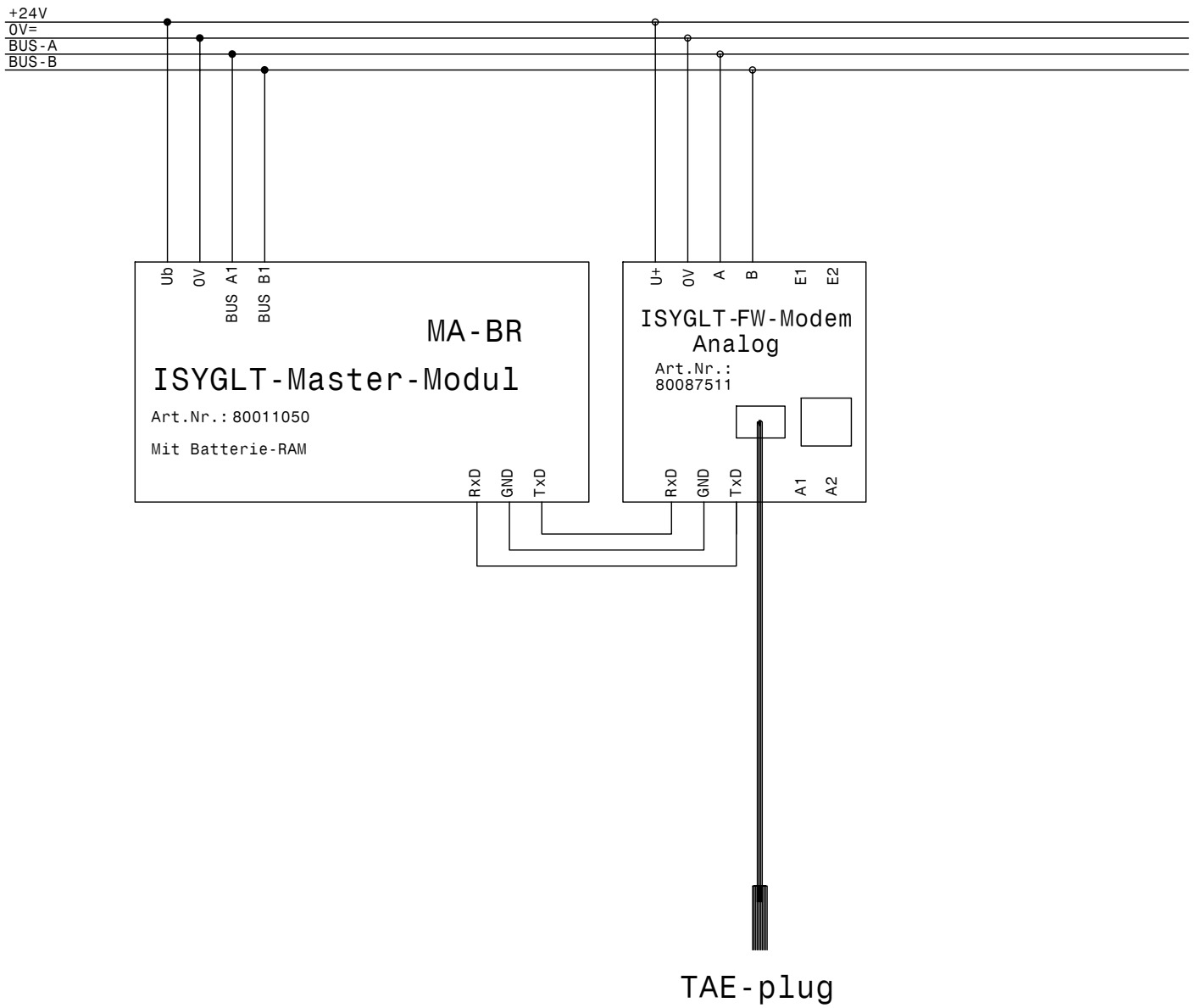

DALI-Konfigurator

